

HURRICANE DAILY

1.880 CUSTOM DESIGN



MEYRA®



An everyday precision device at last



Side panel adapted individually to the sitting position



Clear-cut design

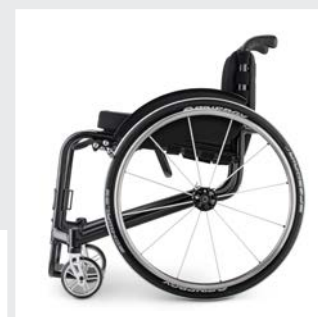

Extremely stable

A precision device for everyday use

EFFICIENCY

- Very durable and extremely stable due to the completely welded frame with immense material strength
- Optimum strength to weight ratio

THERAPEUTIC BENEFIT

- Made to measure wheelchair with open or closed frame ensures utmost precision in adaptation to the individual body measurements and needs of the user
- High weight saving due to welding of seat height, back and seat angle
- The chassis itself can be adjusted just as precisely, providing the greatest possible mobility for perfect handling
- The combination of weight saving and maximum strength, as well as the precisely tailored customisation for an optimal seating position and best ride quality, supports the rehabilitative goals in everyday life and during sports activities

USE

- Active wheelchair for users with high demands in terms of weight and ride quality
- For active wheelchair users in daily living

ORDER / CUSTOM DESIGN COST ESTIMATE

Please fax the completed order form to: +49 5733 922 9311 Customer service: +49 5733 922 311

Billing address / Customer ref. no.:
Delivery address:
Consignment / Comments:



HURRICANE DAILY 1.880 CUSTOM DESIGN

All prices subject to VAT at the prevailing rate! Valid from 01.01.2020 – 31.12.2020.
Our Terms and Conditions as stated at www.meyra.de/AGB shall apply.

Caution!

Please note when using public transport (e.g. trains): the dimensions of the wheelchair may exceed the transport company guidelines. Please enquire beforehand.

When using auxiliary drives, the permissible total weight must not be exceeded.

01 Determination of wheelchair dimensions

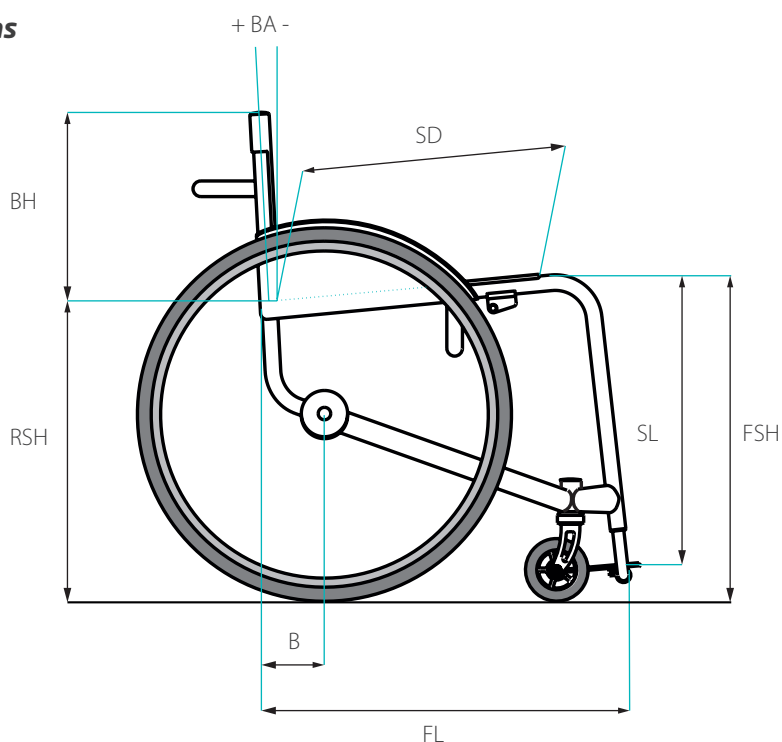
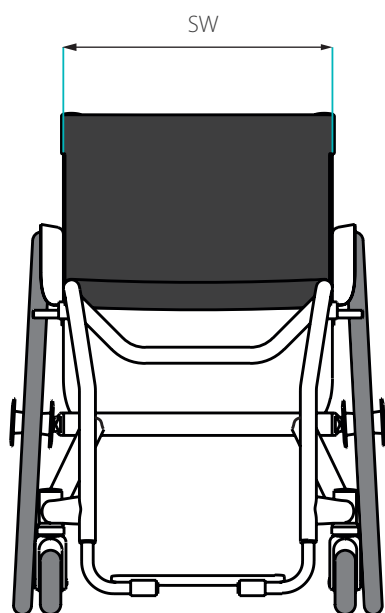

Please select by ticking the relevant boxes

Standard version: If no other selection is made, the standard version will be delivered.

00 Frame design (frame length)

CODE	DESCRIPTION
<input type="checkbox"/> 348	Everyday version special active wheelchair in custom design, incl. 25 mm frame inset per side, up to 150 kg user weight
<input type="checkbox"/> 347	Everyday version special active wheelchair in custom design with open S frame, incl. 25 mm frame inset per side, up to 100 kg user weight
<input type="checkbox"/> 4950	Frame inset according to specification
<input type="checkbox"/> 600	Ergonomically adapted seat angle
<input type="checkbox"/>	Staff number:
<input type="checkbox"/> 3918	Without fitting*
<input type="checkbox"/> 3920	Fitting at MEYRA or at sports event (depending on the work involved, subsequent modifications will be subject to charge*, longer delivery time)
<input type="checkbox"/> 55700	Customisation by MEYRA specialist (appointment by arrangement)
<input type="checkbox"/> 3921	Fitting at specialist retailer (depending on the work involved, subsequent modifications will be subject to charge*, longer delivery time)

* Pre-assembly, if applicable Shipping, dismantling

01 Determination of wheelchair dimensions

	DESCRIPTION	CUSTOM MEASUREMENT:
B*	Axle position in mm	Horizontally from the middle of the drive wheel to the rear edge of the back tube at the level of the seat tube
FL*	Frame length in mm	Horizontally from the front edge of the legrest tube to the rear edge of the back tube at the level of the seat tube
SW*	Seat width in mm	From outer edge of seat tube to outer edge of seat tube
SD*	Seat depth in mm	Front edge of back tube to foremost point of the seat surface
RSH*	Rear seat height in mm	From road level to upper edge of seat tube, rear
FSH*	Front seat height in mm	From road level to upper edge of seat tube, front
MSH	Middle seat height in mm	Only in conjunction with ergonomic seat angle CODE 600
C	Sitting position in mm	Only in conjunction with ergonomic seat angle CODE 600
	Frame inset in mm	
SL*	Distance front seat height to footplate in mm	Vertical upper edge of seat tube to upper edge of footplate
BH*	Back height in mm	
BA*	Backrest angle in degrees	Without specification 90° standard perpendicular to ground Take +/- specification into account

* These measurements are required for the 3D configurator.

New:
3D configurator

You can now have your Hurricane Daily / Hurricane S displayed in advance as a 3D drawing

Please select by ticking the relevant boxes

Standard version: If no other selection is made, the standard version will be delivered.

02 Seat and back systems

Back strap

CODE	DESCRIPTION
<input type="checkbox"/> 235	Seat belt and back strap black
<input type="checkbox"/> 292	Back strap, anatomically adjustable via hook and loop fasteners, breathable

Backrest options

CODE	DESCRIPTION
<input type="checkbox"/> 411	Without push handles
<input type="checkbox"/> 413	Push handles, short, fixed, anatomically shaped
<input type="checkbox"/> 141	Push handles, swing-away
<input type="checkbox"/> 3001	Back hinged to seat, only in conjunction with swivel up side panel CODE 3002

Seat cushion (material and colour as for back)

<input type="checkbox"/> 739	Seat cushion	30 mm	soft
<input type="checkbox"/> 740	Seat cushion	50 mm	soft
<input type="checkbox"/> 719	Seat cushion	30 mm	hard
<input type="checkbox"/> 720	Seat cushion	50 mm	hard

03 Castor wheels

CODE	DESCRIPTION	RIM	TYRES	Ø X W
<input type="checkbox"/> 151	Castor wheel (pair)	Plastic	Solid rubber	100 x 23 mm
<input type="checkbox"/> 325	Castor wheel (pair)	Plastic	Solid rubber	125 x 30 mm
<input type="checkbox"/> 327	Castor wheel (pair)	Plastic	Soft solid rubber	142 x 37 mm
<input type="checkbox"/> 143	Castor wheel (pair)	Plastic	puncture-proof	150 x 32 mm

Smaller steering castors are also available on request, please ask for the sizes separately!

Please select by ticking the relevant boxes

Standard version: If no other selection is made, the standard version will be delivered.

Xtrends castor wheels

CODE	ARTICLE	DESCRIPTION	RIM	TYRES	Ø X W	
<input type="checkbox"/>	689	1068963	Lightwheel (pair)	Plastic	Solid rubber transparent / colour	100 x 23 mm
<input type="checkbox"/>	689	1072385	Castor wheel (pair)	Aluminium silver	Solid rubber	100 x 32 mm
<input type="checkbox"/>	689	1072386	Castor wheel (pair)	Aluminium silver	Solid rubber	125 x 32 mm
<input type="checkbox"/>	689	1081350	Frog legs castor wheel in Storm design	Aluminium silver	Solid rubber	100 x 32 mm
<input type="checkbox"/>	689	1081351	Frog legs castor wheel in Storm design	Aluminium black	Solid rubber	100 x 32 mm
<input type="checkbox"/>	689	1081352	Frog legs castor wheel in Storm design	Aluminium silver	Solid rubber	125 x 32 mm
<input type="checkbox"/>	689	1081353	Frog legs castor wheel in Storm design	Aluminium black	Solid rubber	125 x 32 mm
<input type="checkbox"/>	689	Frog legs castor wheel (pair) <input type="checkbox"/> silver 1081340 <input type="checkbox"/> black 1081341 <input type="checkbox"/> orange 1081342 <input type="checkbox"/> red 1081343 <input type="checkbox"/> blue 1081344 <input type="checkbox"/> white 1083136		Solid rubber	100 x 36 mm	
<input type="checkbox"/>	689	Frog legs castor wheel (pair) <input type="checkbox"/> silver 1081345 <input type="checkbox"/> black 1081346 <input type="checkbox"/> orange 1081347 <input type="checkbox"/> red 1081348 <input type="checkbox"/> blue 1081349 <input type="checkbox"/> white 1083737		Solid rubber	125 x 36 mm	

04 Drive wheels (type)

CODE	DESCRIPTION	Ø	Ø
<input type="checkbox"/>	651 SILVERDESIGN with radial spokes and high flange hub incl. quick release axle (pair)	24"	-
<input type="checkbox"/>	2651 Standard wheel black, incl. quick release axle (pair)	24"	-
<input type="checkbox"/>	695 Active wheel with radial spokes, high flange hub, hollow section rim (Jumbo rim) black (pair) Recommended for user weight over 100 kg or dynamic driving style!	24"	-
<input type="checkbox"/>	4964 Spinergy wheel 12 spoke black, 4 mm, (pair) (White or orange spokes possible on request at a surcharge)	24"	-

Please select by ticking the relevant boxes

Standard version: If no other selection is made, the standard version will be delivered.

Xtrends drive wheels (other wheel variants on request at a surcharge)

CODE	ARTICLE	DESCRIPTION	Ø
<input type="checkbox"/>	688 1085185	Spinergy carbon drive wheel, black spokes incl. Schwalbe One tyres and stainless steel hand rims	24" x 1"
<input type="checkbox"/>	688 1075478	Active wheel with radial spokes, high flange hub, hollow section rim (jumbo rim) in black, incl. Marathon Plus Evolution and stainless steel hand rim (pair) Recommended for user weight over 100 kg or dynamic driving style!	25" x 1"
<input type="checkbox"/>	688 1075479	Active wheel with radial spokes, high flange hub, hollow section rim (jumbo rim) in black, incl. Marathon Plus Evolution and stainless steel hand rim (pair) Recommended for user weight over 100 kg or dynamic driving style!	26" x 1"
<input type="checkbox"/>	688 1068707	CROSS wheel incl. aluminium wheel rim, heavy studded tread tyres and stainless steel hand rim (pair)	24" x 1.75"
<input type="checkbox"/>	688 1068712	Ultra Light incl. 8 bar high-pressure tyres and aluminium hand rim (pair)	24" x 1"
<input type="checkbox"/>	688 1068713	Black Light incl. Marathon Plus Evolution and aluminium hand rim (pair)	24 x 1"
<input type="checkbox"/>	<input type="checkbox"/> blue 1080426 <input type="checkbox"/> red 1080427 <input type="checkbox"/> yellow 1080428	New Active wheel with radial spokes, Schwalbe ONE tyre, hub, rim and hand rim, colour	24 x 1"

Drive wheel sizes

<input type="checkbox"/>	61	Drive wheels	24"
--------------------------	----	--------------	-----

Drive wheel options

Wheel camber

<input type="checkbox"/>	478	1° wheel camber
<input type="checkbox"/>	907	3° wheel camber
<input type="checkbox"/>	454	6° wheel camber
<input type="checkbox"/>	470	Other wheel camber <input type="text"/> Degree measurement on request

Wheelbase extension

<input type="checkbox"/>	899	Wheelbase extension <input type="text"/> mm measurement acc. to specification, only in conj. with CODE 348
--------------------------	-----	--

Please select by ticking the relevant boxes

Standard version: If no other selection is made, the standard version will be delivered.

05 Hand rims and hand rim options

	CODE	DESCRIPTION	Ø
<input type="checkbox"/>	493	Brightly polished stainless steel	24"
<input type="checkbox"/>	168	Optigripp special hand rim for tetraplegics, black rubberised	24"
<input type="checkbox"/>	445	Titanium with 6 brackets	24"
<input type="checkbox"/>	849	Curve L, aluminium black powder coated, ergonomic hand rim profile, H 31 mm, only in conjunction with Active wheel CODE 695 and Spinergy wheel CODE 4964 and standard wheel CODE 651 and 2651	
<input type="checkbox"/>	850	Curve L Tetra Grip, slip-resistant coating, aluminium, suitable for tetraplegics, ergonomic hand rim profile, H 31 mm, only in conjunction with Active Wheel CODE 695 and Spinergy wheel CODE 4964 and standard wheel CODE 651 and 2651	
<input type="checkbox"/>	853	GEKKO, black anodised aluminium with replaceable rubber lip, ergonomic hand rim profile, H 31 mm, only in conjunction with Active wheel CODE 695 and Spinergy wheel art. no. 1073641,1073640 and standard wheel CODE 651 and 2651	
<input type="checkbox"/>	692	Narrow hand rim clearance	24"
<input type="checkbox"/>	693	Wide hand rim clearance	24"

06 Tyres

	CODE	DESCRIPTION	Ø
<input type="checkbox"/>	496	Pneumatic tyre 8 bar	24 x 1"
<input type="checkbox"/>	897	Marathon Plus Evolution tyres, puncture-resistant	24 x 1"
<input type="checkbox"/>	363	Schwalbe ONE plain tread tyres, puncture-resistant	24 x 1"

Note: Tyres consist of a rubber compound which may leave permanent marks or be hard to remove from some surfaces (e.g. plastic, wooden or parquet flooring, rugs and carpets).

We cannot accept liability for any abrasion damage to flooring.

07 Brakes

	CODE	DESCRIPTION
<input type="checkbox"/>	305	Pressure brake for user
<input type="checkbox"/>	2595	"Light" aluminium pressure brake, swing-away

08 Side panels and armrests

Please observe the marked functional properties!

1 = welded 2 = screw-retained 3 = swivel up 4 = with wheel covering

	CODE	DESCRIPTION	1	2	3	4
<input type="checkbox"/>	100	Aluminium side panel, incl. wheel covering	-	●	-	●
<input type="checkbox"/>	3002	Aluminium side panel, swivel up Only in conjunction with hinged back CODE 3001	-	●	●	●
<input type="checkbox"/>	101	Aluminium side panel, incl. wheel covering, welded	●	-	-	●
<input type="checkbox"/>	783	Carbon side panel	-	●	-	●

09 **Footrests**

↑ Height-adjustable ↻ Angle-adjustable

CODE	DESCRIPTION
<input type="checkbox"/> 311	Tubular footrest, aluminium
<input type="checkbox"/> 315	Tubular footrest, aluminium, incl. aluminium footplate
<input type="checkbox"/> 3003	Tubular footrest, aluminium, incl. aluminium footplate, height and angle-adjustable

10 **Wheelchair accessories**
Hand protectors and spoke guards

CODE	DESCRIPTION
<input type="checkbox"/> 490	Transparent (Hurricane The Original)

Support castor wheels

<input type="checkbox"/> 713	One support castor wheel, swing-away, right-mounted
<input type="checkbox"/> 691	Support castor wheels, one pair, swing-away (recommended)

Other accessories

<input type="checkbox"/> 359	Quick fastening calf strap, plastic, reinforced not for S frame CODE 347
<input type="checkbox"/> 261519600	Wheel bag "BLACK WHEEL CASE", suitable for max. 2 x 24" wheels or either 1 x 25" or 1 x 26" wheel
<input type="checkbox"/> 597	Leg protection pad for preventing pressure ulcers

11 **Frame colours**

CODE	DESCRIPTION
<input type="checkbox"/> 176	Aluminium natural
<input type="checkbox"/> 130	Titanium grey
<input type="checkbox"/> 2185	Brown metallic
<input type="checkbox"/> 206	Matt black
<input type="checkbox"/> 216	Jet black
<input type="checkbox"/> 4023	Signal white
<input type="checkbox"/> 227	Red metallic
<input type="checkbox"/> 183	Silver metallic
<input type="checkbox"/> 4922	Green metallic
<input type="checkbox"/> 4923	Orange metallic

Other frame colours possible on request at a surcharge! See range of colours in introduction to catalogue.

Date:	Signature:
-------	------------

USER DETAILS

First name*:	<input type="text"/>
Last name*:	<input type="text"/>
House no./street:	<input type="text"/>
Postcode:	<input type="text"/>
Town/City*:	<input type="text"/>
Country:	<input type="text"/>
Date of birth*:	<input type="text"/>
Diagnosis -1-:	<input type="text"/>
Diagnosis -2-:	<input type="text"/>
Tel. (landline):	<input type="text"/>
Tel. (mobile):	<input type="text"/>
eMail:	<input type="text"/>
Order no.:	<input type="text"/>

Please note that fields marked * are mandatory!

BODY MEASUREMENTS (IN MM):

Please refer to the sketches in the enclosed information!

1) Seat depth*:	<input type="text"/>
2) Seat width*:	<input type="text"/>
3) Chest width:	<input type="text"/>
4) Chest depth:	<input type="text"/>
5) Elbow height:	<input type="text"/>
6) Arm pit height:	<input type="text"/>
7) Back height:	<input type="text"/>
8) Head height:	<input type="text"/>
9) Forearm length:	<input type="text"/>
10) Lower leg length*:	<input type="text"/>
Height*:	<input type="text"/>
Weight (kg)*:	<input type="text"/>

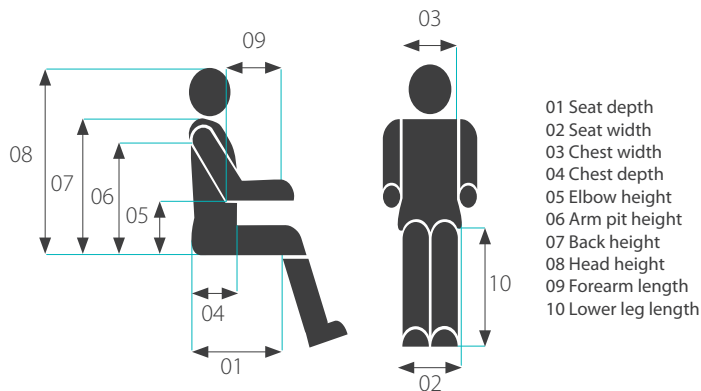

All seat dimensions are always measured **without seat cushion!**

I hereby confirm that all details are complete and correct. I consent to the information/data I provide and the pictures/videos taken of me being passed on to MEYRA GmbH (Meyra-Ring 2, D-32689 Kalletal) and specialist retailer for the purposes of implementing the contract/manufacturing the product.

.....
Date/signature

It is hereby confirmed that all details are complete and correct.

.....
Date/signature of the specialist retailer



02

CODE 141



03

Article 1072385



03

Article 1081342

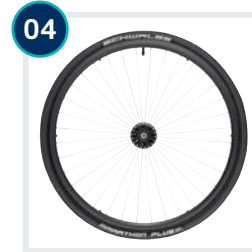

04

CODE 695

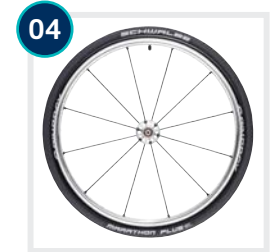

04

CODE 4964

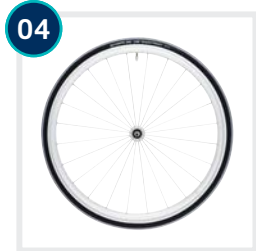

04

Article 1068712

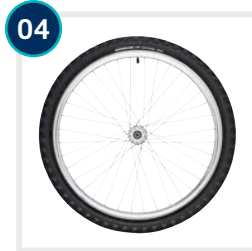

04

Article 1068707

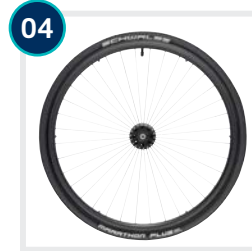

04

Article 1075478

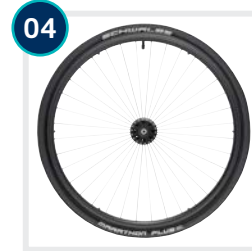

04

Article 1075479

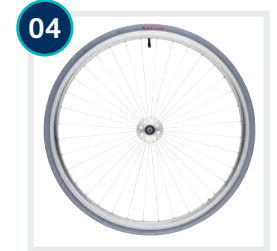

04

CODE 651



05

CODE 849



05

CODE 850

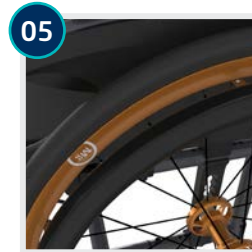

05

CODE 853



07

CODE 2595



08

CODE 100



08

CODE 3002



10

CODE 597



10

CODE 490

1. GENERAL - SCOPE OF APPLICATION

1.1. The following trading and delivery terms and conditions (T&C) of the company MEYRA GmbH shall be valid for all contracts concluded with the customers of the company. They shall also apply to all future transactions with the customer, even without a separate new agreement.

1.2. The customer accepts the T&C of MEYRA GmbH as binding for the present contract and also for all future contracts. Terms and conditions of the customer or third parties shall not apply. MEYRA GmbH shall not be bound by such terms and conditions, even if they are not expressly contradicted again in the individual case.

1.3. These conditions shall only apply if the customer is an entrepreneur (§ 14 German Civil Code, BGB), a legal entity under public law or a special fund under public law.

2. OFFER, CONCLUSION OF CONTRACT

2.1. MEYRA GmbH offers are subject to alteration and non-binding, unless they are expressly designated as binding.

2.2. MEYRA GmbH can accept orders or commissions of the customer within 14 days of receipt by confirming the offer in writing.

2.3. Confirmation of the offer in writing constitutes conclusion of the contract; this shall also apply to any alterations or additions to the orders.

2.4. We reserve ownership rights and copyrights to all documents provided to the customer in connection with the placing of the order. These documents may not be made accessible to third parties without our express written consent. Where we do not accept the customer's offer within the period specified in 2.2, these documents must be returned to us without delay.

3. PRICES

3.1. Prices are calculated exclusively in EURO. All prices are net prices. The respective statutory amount of value added tax shall be paid in addition.

3.2. Unless agreed otherwise in writing, our prices are ex works excluding packaging and shipping. Packaging and shipping costs shall be invoiced separately.

3.3. Insofar as list prices are used as a basis, the price list valid at the time the order is placed shall apply. Price changes shall be permissible if more than four months lie between the conclusion of the contract and the agreed delivery date. In the event of wages or material costs increasing thereafter until completion, we shall be entitled to increase the price appropriately in line with the cost increases. The customer shall only be entitled to withdraw from the contract if the price increase significantly exceeds the increase in the general cost of living between order and delivery.

3.4. For follow-up orders, MEYRA GmbH shall not be bound to the prices from a previous contract.

3.5. If the order value is below 150.00 € net value of goods, a minimum quantity surcharge of 9.50 € including freight shall be charged.

4. DISPATCH, TRANSFER OF RISK

4.1. The place of performance for deliveries is the registered office of MEYRA GmbH, unless expressly agreed otherwise.

4.2. If the goods are dispatched to the customer at the customer's request, the risk of accidental loss or accidental deterioration of the goods shall pass to the customer as soon as the goods (including partial deliveries) have been handed over to the third party designated to carry out the dispatch. This shall apply irrespective of whether the goods are dispatched from the place of performance or who bears the freight costs.

4.3. In the event of claims due to transport damages or losses being asserted against MEYRA GmbH, the customer must note the damage on the freight documents or, in the event of losses, arrange for this to

be recorded immediately and notify us of this within one week.

4.4. Insurance against transport damage shall only be taken out at the express request and expense of the customer.

4.5. In the event of delays in handover or dispatch for which the customer is responsible, the risk shall pass to the customer upon notification of readiness for dispatch.

4.6. Where the customer specifies no specific instructions, the choice of the transport route and means shall be made by MEYRA GmbH, without guarantee and liability for the cheapest and fastest mode of dispatch.

5. DELIVERY TIME, SCOPE OF DELIVERY

5.1. Prospective delivery periods are to be understood as estimated delivery periods, unless a specific date has been expressly stipulated in writing.

5.2. If the parties have agreed a delivery period, this shall commence on the date the order is confirmed. The delivery period shall be deemed to have been observed if the goods have left the factory or notification of readiness for dispatch has been given by the end of the delivery period.

5.3. Compliance with agreed delivery and performance dates assumes the timely receipt of all documents to be provided by the customer as well as the timely provision of all necessary information and the fulfilment of all other obligations by the customer. Should these conditions not be fulfilled on time, the deadlines shall be extended accordingly.

5.4. MEYRA GmbH shall not be liable for delays in delivery arising from force majeure or other events not foreseeable at the time of the conclusion of the contract (e.g. strike, operational disturbances, delayed delivery by our own suppliers, transport delays, unfavourable weather conditions, etc.) for which it is not responsible. The delivery period shall be extended by the duration of the temporary hindrance to performance for which MEYRA GmbH is not responsible, plus a reasonable period for resumption.

5.5. If the resulting delays exceed a period of six weeks, both parties to the contract shall be entitled to withdraw from the contract with regard to the scope of performance concerned.

5.6. MEYRA GmbH shall be entitled to make partial deliveries insofar as the partial delivery is usable for the customer within the scope of the contractual purpose, the delivery of the remaining goods is guaranteed and no additional costs arise for the customer as a result.

6. PAYMENT

6.1. Invoice amounts must be paid in full to one of the bank accounts specified by us within 30 days of receipt of the invoice. If the invoice is not for a spare part delivery or a repair invoice, the customer shall be entitled to a 2 % discount if payment is made within eight days of receipt of the invoice.

6.2. We shall only accept cheques and bills of exchange if this has been expressly agreed beforehand. Acceptance shall be on account of performance. Invoice adjustments for cheques and bills of exchange are subject to redemption. The value shall be credited effective as of the day we have access to the equivalent amount.

6.3. If the customer fails to pay on the due date, the outstanding amounts shall bear interest at 8 % p.a. above the respective base interest rate. We reserve the right to assert higher damages caused by default.

6.4. In the event of the customer being in arrears with a payment, all other claims based on the same legal relationship shall become due for payment immediately without the need for separate notification.

6.5. The customer shall only be entitled to offset if his counterclaims have been legally established or are undisputed. The customer shall only be authorised to exercise a right of retention insofar as his counterclaim

is based on the same contractual relationship.

6.6. MEYRA GmbH shall be entitled to assign its claims from deliveries and services.

7. RETENTION OF TITLE

7.1. The goods delivered by MEYRA GmbH shall remain the property of MEYRA GmbH until complete settlement of all claims against the customer, including future claims.

7.2. The customer may sell the reserved goods in the ordinary course of business. He shall not be entitled to dispose of the goods in any other way, in particular by way of security assignment or pledge. The claims of the customer arising from the resale of the reserved goods (including other claims such as insurance claims or claims arising from unlawful acts in the event of loss or destruction) are hereby assigned to MEYRA GmbH by way of security. MEYRA GmbH accepts the assignment. The customer is entitled to collect the assigned claim as long as he fulfils his payment obligations. In the event of the customer being in default of payment, we shall be entitled to revoke the collection authorisation.

7.3. If the reserved goods are processed by the customer, it is hereby agreed that the processing shall take place in the name and for the account of MEYRA GmbH as manufacturer and that MEYRA GmbH shall directly acquire ownership or - if the processing takes place from or in connection with materials of several owners or the value of the processed item is higher than the value of the delivered goods - co-ownership (fractional ownership) of the newly created item in the ratio of the value of the subject of delivery to the value of the newly created item. If MEYRA GmbH loses its property through combination or commingling, or if it should not become the owner of the subject of delivery in the case of processing, the customer shall hereby in advance transfer to MEYRA GmbH a co-ownership share in the uniform item corresponding to the proportional value of the subject of delivery. MEYRA GmbH hereby accepts the offer. The delivery shall be replaced by gratuitous custody.

7.4. The customer is obliged to inform us immediately of any access by third parties to the goods delivered under retention of title and to provide us with the information and documents required to assert our rights. At the same time the customer shall inform the third party of MEYRA GmbH's right of ownership without being called upon to do so. Any costs arising in this connection shall be borne by the customer.

7.5. MEYRA GmbH undertakes to release the securities to which it is entitled at the customer's request insofar as they exceed the value of the claims to be secured by more than 20%. The selection of the securities to be released is incumbent upon MEYRA GmbH.

7.6. In the event of an insolvency petition concerning the customer, we hereby prohibit the resale or processing of our reserved goods and revoke our authorisation to collect the claims assigned to us.

7.7. In the event of default in payment by the customer, we shall be entitled to demand immediate surrender of the reserved goods.

8. GUARANTEE / LIABILITY

8.1. The customer shall inspect the delivered goods immediately upon delivery. Insofar as obvious defects are concerned or defects that would have been found in the course of a thorough inspection, the customer must notify us of complaints in writing within one week of receipt of the delivery. After expiry of this period, any liability for these defects shall be excluded. Guarantee claims for concealed defects shall only exist if they are notified to us in writing within one week of being detected.

8.2. In cases of defective delivery, we shall have the right, at our discretion, to repair the defective item or to replace it with a new delivery free of defect. The customer is obliged to make the defective item available to us free of charge for inspection and rec-

tification. If the rectification of defects or subsequent delivery does not succeed, if it is not provided within a reasonable period of time or if it is rejected by us, the customer may, at his discretion, withdraw from the contract or reduce the purchase price. It is not necessary to set a time limit in cases where this is not required by law.

8.3. The guarantee shall lapse if the customer changes the subject of delivery or has it changed by third parties without our consent and the removal of the defect is thereby rendered impossible or unreasonably difficult. The customer shall, however, in any case bear the additional costs of remedying the defect incurred as a result of the change.

8.4. Any guarantee which we may assume towards the first user of the rehabilitation equipment shall not be affected by the above provisions.

8.5. Excluded from the warranty is the function-related wear of all articles, assemblies, batteries and spare parts supplied by us, as well as the inappropriate or improper storage, use or handling of the goods.

8.6. Further claims of the customer, in particular for damages instead of performance and for compensation of any other direct or indirect damage - including accompanying or consequential damage, irrespective of the legal basis - are excluded. This shall not apply if MEYRA GmbH has fraudulently concealed a legal or material defect or if the damage is based on intent or gross negligence of MEYRA GmbH, its legal representatives or vicarious agents or a negligent violation of essential contractual obligations exists. Essential contractual obligations are such obligations of which the fulfilment is essential for the proper execution of the contract and on the observance of which the contractual partner regularly relies and may rely. In the case of damage to property and financial losses caused by slight negligence, however, the liability of MEYRA GmbH to pay compensation is limited in amount to foreseeable damage typical for this type of contract. Furthermore, physical injury and/or damage to health caused by a culpable breach of duty on the part of MEYRA GmbH, its legal representatives or vicarious agents are not excluded.

8.7. Liability under the German Product Liability Act (Produkthaftungsgesetz) remains unaffected.

9. LIMITATION

Claims of the customer on account of material defects shall become time-barred two years after handover/delivery of the goods to the customer. The period of limitation for replacement devices and repairs shall be one year from handover/delivery of the goods to the customer. Excluded from this are claims for damages due to injury to life, limb or health and/or claims for damages on account of grossly negligent or intentionally caused damage by MEYRA GmbH or its vicarious agents. In this respect, the statutory limitation periods shall apply.

9.1. REPLACEMENT DEVICE SERVICE

Irrespective of the guarantee, MEYRA GmbH shall offer its customers the option of replacing defective devices with refurbished ones. The following provisions shall apply in respect of these devices offered in exchange:

- Replacement devices are refurbished and technically in order.

- The defective device must be returned to MEYRA GmbH

free of charge within 15 working days.

The returned device shall become our property.

- If the device is not returned, we shall charge 95% of the new retail price for the replacement device delivered.

- The returned device must correspond to the type and design of the delivered replacement device.

Moreover the device must be reusable

and may only show signs of wear appropriate to normal use.

- It is incumbent upon MEYRA GmbH to assess whether the returned device fulfils the aforementioned conditions.

Should the conditions not be met, we shall also charge the aforementioned amount less the residual value of the returned device for the delivered replacement device.

10. PRODUCT SAFETY

10.1. PRODUCT RECALL

In the event of a product recall being necessary on account of a defect in the delivered goods or due to existing legal obligations, the customer is obliged to cooperate in implementing the product recall in order to enable an efficient execution thereof. In particular, the customer is obliged in the event of a necessary product recall to inform MEYRA GmbH about the whereabouts of the subjects of delivery in the further supply chain up to the end customer. For this purpose, the customer must maintain suitable documentation on an on-going basis about the whereabouts of the goods and make this available to MEYRA GmbH on request. Insofar as the customer supplies the delivered goods to resellers, the customer is obliged to contractually impose on the reseller the obligations to cooperate specified here in order to ensure the execution of an efficient product recall.

10.2. The customer is obliged to instruct end customers in the handling and use of the delivered products by trained specialist staff. Insofar as the customer supplies the delivered goods to resellers, the customer is obliged to contractually impose on the reseller the duty to instruct in handling and use of the delivered product specified here.

11. LIABILITY FOR CONSTRUCTIONAL MODIFICATIONS

Attention is drawn to the fact that stricter statutory provisions apply in the case of MY INDIVIDUAL. Constructional modifications of MEYRA GmbH articles by the customer or a third party commissioned by him are only permissible if they comply with the safety requirements and have previously been consented to in writing by our management. For this purpose, a modified model and a design drawing shall be made available to us on request. In the event of constructional changes being made without the written consent of our management and damage arising to third parties as a result of the changes for which we are liable in the external relationship, the customer is obliged to indemnify us in the internal relationship against all claims of the third party.

12A. RETURN OF FINISHED PRODUCTS AND ASSEMBLIES

Goods returned without an enclosed copy of the delivery note or invoice will not be accepted for return. Goods returned (in their original packaging and absolutely as new) will be credited with 80% of the net value of the goods. Excluded from return are articles delivered more than three months previously, MY INDIVIDUAL, hygiene products, used and/or filled batteries and articles under EUR 100.00 net commodity value. Individually manufactured wheelchairs (e.g. children's and adaptive wheelchairs) are likewise excluded. The sender shall bear the transport risk. Any cleaning and/or disinfection costs incurred in connection with approved returns will be charged at a flat rate of at least EUR 79 net.

12B. ORDER CANCELLATIONS FOR FINISHED PRODUCTS

12B.1 It is not possible to cancel orders without the prior consent of MEYRA GmbH.

12B.2 Cancellations must be made in writing.

12B.3 If the cancellation of finished, deliverable products has been approved, the following shall apply:

- Rehabilitation articles will be credited in full.

Custom wheelchairs and sports wheelchairs will not be accepted for cancellation.

- In the event of cancellation of adaptive wheelchairs, 20% of the net value of the goods will be retained.

The cancellation fee for power chairs and scooters is 5%. A 10% cancellation fee will be charged for standard and lightweight wheelchairs.

12C. RETURN / DISPOSAL

Our prices are exclusive of the costs for the return and disposal of complete old devices of users other than private households. On request, we shall also organise the return and reuse/disposal of such devices, insofar as these were sold by us, against reimbursement of the costs incurred. Returns are not possible without the prior consent of MEYRA GmbH.

13. USE OF PERSONAL DATA

We are entitled to store personal data about the customer within the scope of the legal provisions, in particular the General Data Protection Regulation, and to process such data within the company.

14. PLACE OF JURISDICTION, APPLICABLE

law, severability clause

14.1. Unless expressly agreed otherwise, the place of performance shall be the registered office of MEYRA GmbH in Kalletal-Kalldorf.

14.2. For all legal disputes arising from the contractual relationship, the place of jurisdiction shall be determined by our registered office in Kalletal-Kalldorf. We are also entitled to bring legal action against the customer at his place of jurisdiction.

14.3. The law of the Federal Republic of Germany shall apply while excluding the UN Convention on Contracts for the International Sale of Goods.

14.4. Should individual provisions of these Terms and Conditions be wholly or partially void or ineffective, the validity of the remaining provisions shall remain unaffected.