



# **TIGA**

User Manual



# Thank you

for buying RGK...

We hope the product and service you have received has met your expectations. Please take time to read the instructions contained within, to familiarise yourself with your new RGK chair and to ensure you get maximum performance and longevity from it.



Russel Simms,  
Commercial Director



Greg Eden,

## WARNING!

Do not operate this equipment without first reading and understanding this manual. If you are unable to understand the warnings and instructions, contact a healthcare professional (doctor / therapist) before attempting to use this equipment - otherwise injury or damage may result.

# Contents

03	User Manual Contents	23	Procedure 5
04	Special Notes		Replacing Hand Rims; Tyres & Inner Tubes
05	Safety Summary	24	Procedure 6
07	Product Description		Adjusting and Replacing The Camber Bar
09	Production Identification	25	Procedure 7
10	Handling Of Wheelchairs		Replacing Front Fork Assembly & Castors Wheels
10	Tilting	27	Procedure 8
	Tilting Unattended		Wheel Locks Adjusting / Replacing Wheel Locks
12	Reaching, leaning & bending forward	28	Procedure 9
13	Stairs		Footrest Standard Footrest Adjustment / Replacement Installing / Adjusting Optional Angle Adjustable Footrest
13	Transferring	29	Procedure 10
15	Lengthening and shorting the wheel base		Folding and Unfolding the backrest
15	Manoeuvring your wheelchair	31	Procedure 11
16	Safety Inspection Checklist		Adjusting Height Adjustable Stroller Handles: Fold Down Pushing Handles and Screw In Pushing Handles
17	Troubleshooting / Maintenance	32	Procedure 12
	Troubleshooting Guide Mechanical		Adjust the Anti-Tipper
	Maintenance Safety Precautions	33	Procedure 13
18	Suggested Maintenance Procedures		Side Guards
19	Procedure 1	33	Procedure 14
	Backrest Adjustments		Straps
	Adjusting/Replacing Back Upholstery	34	Technical
20	Procedure 2		For your warranty - see back cover
	Seat Cushion / Sling Replacement		
	Seat Upholstery Replacement		
21	Procedure 3		
	Removing & Fitting Rear Wheels		
22	Procedure 4		
	Adjusting The Quick-Release Axle		

# Special Notes

The manual must be read thoroughly to avoid damage when handling and using your RGK Wheelchair.

## ► Definitions of words used in this manual

### ▲ WARNING

Advice to the user of a Potential Risk of injury if the advice is not followed.

### ▲ CAUTION

Advice to user that Potential Damage to equipment may occur if the advice is not followed.

### ► NOTE:

General advice or best practice

### ▲ WARNING / CAUTION

notices as used in this manual apply to hazards or unsafe practices which could result in personal injury or property damage.

### ► Notice

The information contained in this document is subject to change without notice.

## ► Wheelchair Selection

As a manufacturer of wheelchairs, RGK endeavours to supply a wide variety of wheelchairs to meet many needs of the end user. However, final selection of the type of wheelchair to be used by an individual rests solely with the user and his/her health care professional capable of making such a selection.

DO NOT use the footplate as a platform when getting in or out of the wheelchair.

Always wear your seat restraint, if recommended.

The wheelchair shown and described in this user guide may not correspond in every detail exactly to your own model and accessories.

However, all instructions are completely relevant, regardless of additions that you may have added at the time of order

The expected life of your RGK wheelchair is 5 years of normal use by a single user. The expected life of your wheelchair is above all dependent on the user's disability and the maintenance of the wheelchair. Different users may experience both a shorter and a longer service life for their wheelchair than those stated above.

Please DO NOT use or fit any 3rd party components to the wheelchair unless they are officially approved by RGK Wheelchairs Ltd.

# Safety Summary

## WARNING / CAUTION

### Transportation

Wheelchair tie-down restraints and seat restraints.

RGK recommends that wheelchair users not be transported in vehicles of any kind while in wheelchairs. It is RGK's position that users of wheelchairs should be transferred into appropriate seating in vehicles for transportation and use be made of the restraints made available by the auto industry.

RGK cannot and does not recommend any wheelchair transportation systems.

As regards restraints-seat belts, it is the obligation of the dealer, therapists and other health care professionals to determine if a seating restraint is required to ensure the safe operation of this equipment by the user.

Serious injury can occur in the event of a fall from a wheelchair.

DO NOT use the footplate as a platform when getting in or out of the wheelchair.

Always wear your seat restraint, if recommended.

Securing your wheelchair, ensure that the wheelchair is placed safely in a seat so that it cannot overturn or roll. If possible, secure the wheelchair with the car's safety belt.

## Safety Summary

Never exceed the maximum load of 125KG this includes any additional items carried on the wheelchair. If you exceed the maximum load, this can lead to permanent damage to your RGK wheelchair or you may fall, tip over, lose control which may lead to serious injury to either yourself or third parties.

# Safety Summary

## ► Weight Training

RGK DOES NOT recommend the use of its wheelchairs as a weight training apparatus. RGK products have NOT been designed or tested as a seat for any kind of weight training. If occupant uses said wheelchair as a weight training apparatus, RGK shall NOT be liable for bodily injury and the warranty will be voided immediately.

“Safety and Handling” of the wheelchair requires the close attention of the wheelchair user as well as the assistant. This manual points out the most common procedures and techniques involved in the safe operation and maintenance of the wheelchair. It is important to practice and master these safe techniques until you are comfortable in manoeuvring around the frequently encountered architectural barriers.

Use this information only as a “basic” guide. The techniques that are discussed on the following pages have been used successfully by many.

Individual wheelchair users often develop skills to deal with daily living activities that may differ from those described in this manual. RGK recognises and encourages each individual to try what works best for him/her in overcoming architectural obstacles that they may encounter. Techniques in this manual are a starting point for the new wheelchair user and assistant with “safety” as the most important consideration for all.

## ► Stability and Balance

To assure stability and proper operation of your wheelchair, you must at all times maintain proper balance. Your wheelchair has been designed to remain upright and stable during normal daily activities as long as you do not move beyond the centre of gravity.

Virtually all activities which involve movement in the chair have an effect on the centre of gravity.



Make sure the castors are pointing in the forward position whenever you lean forward. This can be achieved by advancing the chair and then reversing it in a straight line. See Fig 1.

Coping with the irritation of everyday obstacles can be alleviated somewhat by learning how to manage your wheelchair. Keep in mind your centre of gravity to maintain stability and balance.

### △ WARNING

The position of the footrest, camber tube, height, as well as the tautness of the back upholstery are directly related to the chairs stability. Any change to one or any combination of the three may cause the chair to decrease in stability. Use EXTREME caution when using a new seating position for the first time.

# RGK TIGA Manual

## Propelled Wheelchair

### ► Product Description

TIGA manually propelled wheelchair combines the bespoke, personal values and perfection. Chair is suitable for a wide range of users whose mobility has been reduced or removed by a disability or chronic illness. The TIGA is hand built from aerospace grade aluminium. Two frame design options are available either open frame or closed frame design, delivering a lightweight and versatile chair. It is the ultimate lightweight wheelchair with its smooth clean curves and a simplistic design make it the perfect complement to its lightweight design. The design incorporates an aluminium frame, with either an integrated aluminium camber bar and footrest suited to the more experienced users looking for the lightest option, or can be prescribed with an adjustable aluminium camber bar and adjust height footrest, scissor or push to lock brakes, adjustable tension seat sling, backrest and calf strap all as standard, with further options available.

The design accommodates a wide range of disabilities for all ages of user up to a maximum user weight of 125kg.

Suitability is dependent upon the degree and nature of disability and must be determined through a thorough Client risk assessment carried out by a qualified medical professional or RGK personnel. This wheelchair is suitable for a means of transfer from one location to another where physical mobility is impaired or reduced and is not designed for any other purpose.

Consideration must be given at point of prescription to required usage with regard to the capabilities of the user and the environment and terrain on which the product will be used.

The TIGA, manufactured by RGK Wheelchairs Ltd, is placed on the EU market, CE marked, as a Class 1 Medical Device and complies with the Essential Requirements of the Medical Device Directive 93/42/EEC.

By definition all wheelchairs are marketed as a medical device where a "medical device"\* means an instrument, apparatus, appliance, material or other article, whether used alone or in combination, together with any software necessary for its proper application, which -

(a) is intended by the manufacturer to be used for human beings for the purpose of-

(i) diagnosis, prevention, monitoring, treatment or alleviation of disease,

(ii) diagnosis, monitoring, treatment, alleviation of or compensation for an injury or handicap,

(iii) investigation, replacement or modification of the anatomy or of a physiological process, or

(iv) control of conception; and

(b) does not achieve its principal intended action in or on the human body by pharmacological, immunological or metabolic means, even if it is assisted in its function by such means.

\* definition taken from the Medical Devices Directive 93/42/EEC



# RGK TIGA Manual Propelled Wheelchair

- A Backrest
- B Brakes
- C Rear Wheel
- D Front Castor
- E Front Castor Forks
- F Footplate
- G Footplate cover
- H Camber Bar
- I Frame
- J Under Seat Brace Bar
- K Cushion & Cover
- L Sideguard

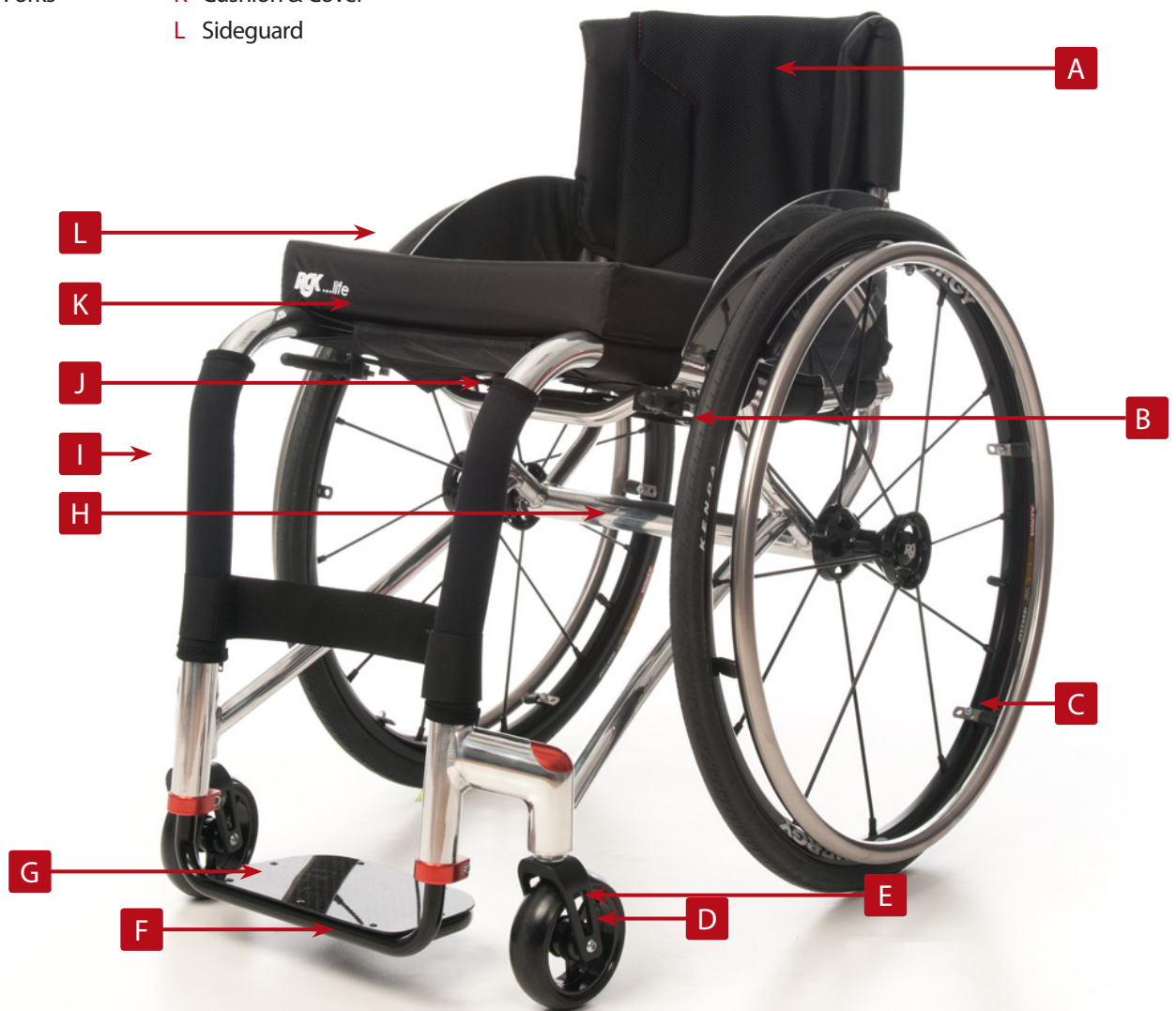



# Identification / Serial Number – Bespoke to you

The serial number of your bespoke product is located on either the under seat cross brace bar (I Product Description) or camber bar (J Product Description).

Please provide the following information whenever you have to order replacement parts.

Serial Number

Name

Dealer

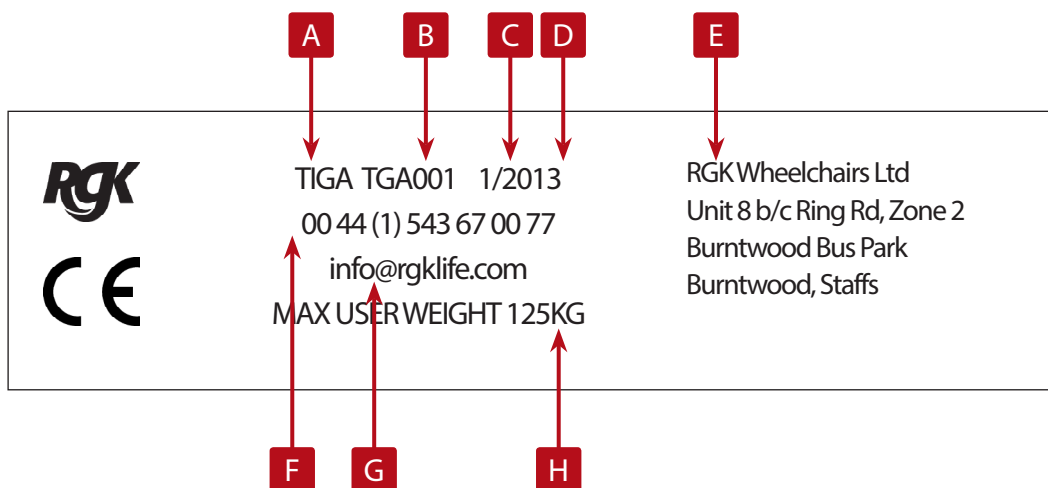

## ► RGK Chair Label Information

- |                       |                               |
|-----------------------|-------------------------------|
| A Model               | E Manufacturer Address        |
| B Chair Serial Number | F Manufacturer Contact Number |
| C Month Manufactured  | G Manufacturer Email Address  |
| D Year Manufactured   | H Maximum User Weight         |

# Safety Handling of your Wheelchair

## ⚠ WARNING

A note to wheelchair assistants

DO NOT attempt to lift the wheelchair by any removable (detachable) parts.

Lifting by means of any removable (detachable) parts of a wheelchair may result in injury to you the assistants and damage your wheelchair.

## ► NOTE – Wheelchair Assistants

When assistance to the wheelchair user is required, remember to use good body mechanics. Keep your back straight and bend your knees whenever tilting the wheelchair or traversing kerbs, or any other impediments

## ► Tilting

When tilting the wheelchair, an assistant should grasp the back of the chair on a non-removable (non-detachable) part. Inform the chair occupant before tilting the chair and remind him/her to lean back.

Be sure the occupant's feet and hands are clear of all wheels. Apply a continuous motion until the balance point is achieved.

At this point, the assistant will feel a difference in the weight distribution. Turn the chair in the desired direction if necessary. Slowly lower the chair in one continuous movement. See Fig 2.

DO NOT let the chair drop the last few inches to the ground. This could result in injury to the occupant.

Fig 2

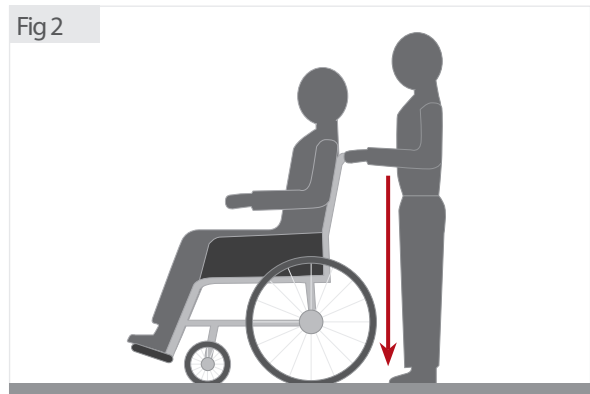

## ⚠ CAUTION

DO NOT tilt the chair without assistance. After mastering the techniques of tilting the chair, use this procedure to tackle kerbs, short stairs, etc.

### ► Method 1

The assistant should tilt the chair until the front castors clear the kerb. Roll the chair forward and lower the front castors to the pavement. Push the chair forward until the rear wheels roll up and over the kerb. See fig 2 and fig 3.

Fig 2



Fig 3

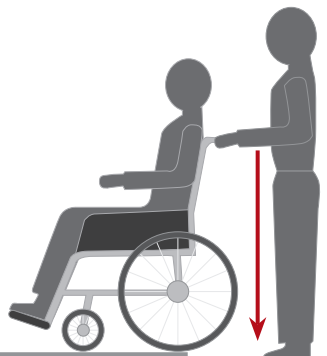

### ► Method 2

The assistant should stand on the pavement and turn the chair so that the rear wheels are against the kerb. The chair should be tilted back to the balance point and, in one continuous movement, the rear wheels should be pulled up and over the kerb. See fig 4.

DO NOT return the front castors to the ground until the chair back has been pulled backward far enough to clear the edge of the kerb. Unless the assistant has exceptional upper body strength, it is recommended that two assistants be utilised when choosing Method 2.

Fig 4

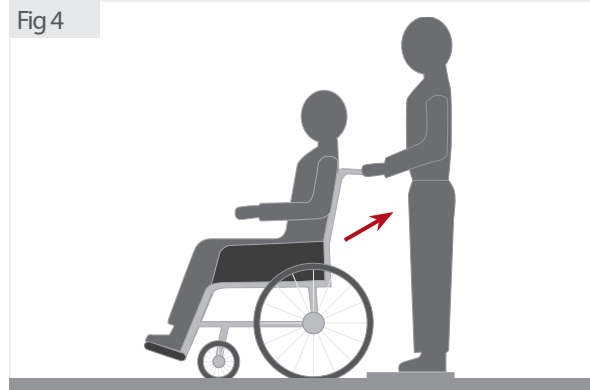

#### ⚠ WARNING

DO NOT attempt to lift a wheelchair by lifting on any removable (detachable) parts. Lifting by means of any removable (detachable) parts of a wheelchair may result in injury to the user or damage to the wheelchair.

#### ⚠ WARNING

Extreme caution is advised when it is necessary to move an occupied wheelchair up or down the stairs. RGK recommends using two assistants and making thorough preparations. Make sure to use ONLY secure, non-detachable parts for hand-hold supports.

**NOTE**

After mastering the techniques of tipping the wheelchair, use the following method to tackle kerbs.

! If your wheelchair is fitted with anti-tips ensure these are either rotated and facing upwards or even removed.

**Tackling Kerbs unattended**

Push towards the kerb, lean back balancing the wheelchair on its rear wheels so that the castor wheels lift off the ground, high enough to clear the kerb. Grasp both hand rims firmly pushing forward, while at the same time lean your upper body forward. See fig 5.

! Remember to rotate or attach your anti-tip

**Dropping down a Kerb unattended**

If your wheelchair is fitted with anti-tips ensure these are either rotated and facing upwards or even removed.

Approach the kerb, lean back balancing the your wheelchair on its rear wheels so that the front wheels lift off the ground. With a firm hold push forward allowing the wheelchair to carefully drop and set down on all four wheels. See fig 6.

! Remember to rotate or attach your anti-tip

Fig 5

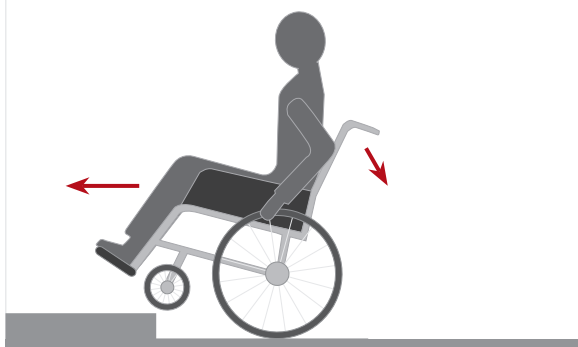

Fig 6

**Reaching, Leaning and Bending – Forward**

When reaching for any objects either in front, to the side or behind your wheelchair make sure that you do not lean too far out of your wheelchair, as this will change your centre of gravity, and there is a risk of tipping or losing your balance.

The hanging of additional load's such as a laptop bag or back pack on your backrest can affect the rearward stability of your chair. This can cause your wheelchair to lift at the front and the chair to tip backwards. Potential causing injury.

### ► Stairways

Follow this procedure for moving the chair between floors when an elevator is NOT available. We always recommend using two assistants for this procedure.

1. After the chair has been tilted back to the balance point, one assistant (in the rear) backs the chair up against the first step, while securely grasping a non-removable (non-detachable NOT the push handles) part of the chair for leverage.
2. The second assistant, with a firm hold on a non-detachable part of the framework, lifts the chair up and over the stair and steadies it as the first assistant places one foot on the next stair and repeats the procedure.
3. The chair should not be lowered until the last stair has been negotiated and it has been rolled away from the stairway. See fig 7.

If your RGK wheelchair is fitted with anti-tips please ensure these are either rotated upwards or swung under your wheelchair.

Fig 7



### ⚠ WARNING

Do not attempt to lift a chair by any removable / detachable part. Ensure good contact with the frame is made.

### ► NOTE

#### Escalators

DO NOT use an escalator to move a wheelchair between floors. Serious bodily injury may occur.

### ► Transferring to and from other seats

#### ⚠ WARNING

BEFORE attempting to transfer in or out of the wheelchair, every precaution should be taken to reduce the gap distance. Turn both castors toward the object you are transferring onto. See Fig 8. Also be certain the wheel locks are engaged to help prevent the wheels from moving.

Fig 8



#### ⚠ CAUTION!

When transferring, position yourself as far back as possible in the seat. This will prevent damaged upholstery and the possibility of the chair tipping forward.

### ► Transferring to and from other seats

#### ⚠ WARNING

RGK does NOT recommend that your wheelchair be transported up or down stairways with you in it.

#### ⚠ WARNING

DO NOT attempt to lift the wheelchair by any removable (detachable) parts. Lifting by means of any removable (detachable) parts of a wheelchair may result in injury to you the assistants and damage your wheelchair.

#### ► NOTE

##### Wheelchair Assistants

When assistance to the wheelchair user is required, remember to use good body mechanics. Keep your back straight and bend your knees whenever tilting the wheelchair or traversing kerbs, or any other impediments.

#### ► NOTE

This activity may be performed independently provided you have adequate mobility and upper body strength. Position the chair as close as possible along side the seat to which you are transferring, with the front castors pointing toward it, engage wheel locks. Shift body weight into seat with transfer.

During independent transfer, little or no seat platform will be beneath you. Use a transfer board if at all possible.

Fig 9



#### ⚠ WARNING

DO NOT attempt to reach objects if you have to move forward in the seat or pick them up from the floor by reaching down between your knees.

#### ⚠ WARNING

The position of the footrest, camber tube and rear seat height, as well as the tautness of the back upholstery are directly related to the chairs stability. Any change to one or any combination of the four may cause the chair to decrease in stability. Use EXTREME caution when using a new seating position for the first time.

Many activities require the wheelchair owner to reach, bend and transfer in and out of the wheelchair. These movements will cause a change to the normal balance, the centre of gravity, and the weight distribution of the wheelchair. To determine and establish your particular safety limits, practice bending, reaching and transferring activities in several combinations in the presence of a qualified health professional BEFORE attempting active use of the wheelchair.

Proper positioning is essential for your safety. When reaching, leaning, bending or bending forward, it is important to use the front castors as a tool to maintain stability and balance. See Fig 1.



► **Lengthening and shortening the wheelbase**

Lengthening the wheelbase will increase the stability and maintain standard manoeuvrability of the chair.

Shortening the wheelbase will increase the manoeuvrability and distribute additional weight onto the rear wheels.

To lengthen the wheelbase move Camber Bar toward the rear of the frame. See Fig 10.

To shorten the Wheelbase move the Camber Bar toward the front of the frame. See Fig 10.

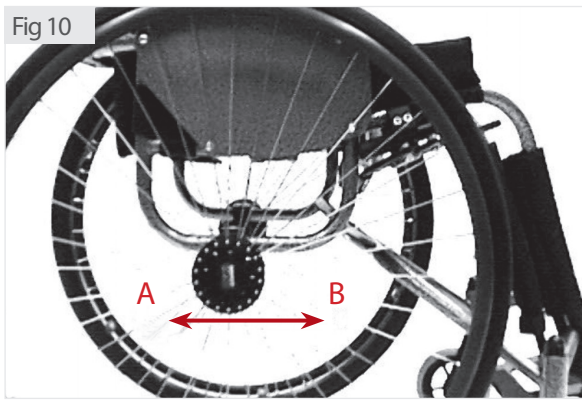

A = Rearward / Lengthen B = Forward / Shorten

► **Manoeuvring your RGK wheelchair**

**⚠ WARNING**

BEFORE attempting to manoeuvre your new wheelchair it is important to practice and master these techniques until you comfortable and competent.

Remember to lean your upper body further forward when going up slopes and steps. See Fig 11

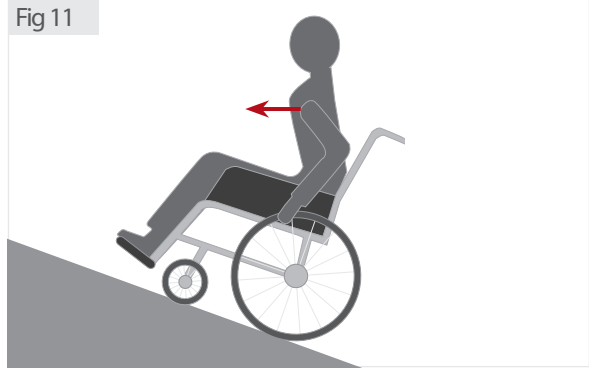

Remember to lean your upper body further back when going down slopes and steps. See Fig 12.



Never try to climb and descend a slope diagonally. See figure 13.

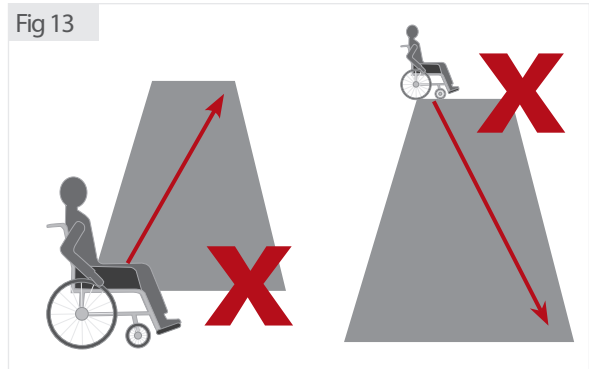

# Safety Inspection Checklist

► **NOTE:** Regular cleaning will reveal loose or worn parts and enhance the smooth operation of your wheelchair. To operate properly and safely, your wheelchair must be cared for just like any other vehicle. Routine maintenance will extend the life and efficiency of your wheelchair. Initial adjustments should be made to suit your personal body structure and preference. Thereafter follow these maintenance procedures.

Item	Initially	Inspect / Adjust Weekly	Inspect / Adjust Monthly	Inspect / Adjust Yearly
<p>► <b>General</b></p> <ul style="list-style-type: none"> <li>Wheelchair rolls straight (no excessive drag or pull to one side).</li> </ul>	✓			✓
<p>► <b>Wheel Locks</b></p> <ul style="list-style-type: none"> <li>Do not interfere with tyres when rolling</li> <li>Pivot points free of wear and looseness</li> <li>Wheel locks easy to engage</li> </ul>	✓ ✓ ✓		✓ ✓ ✓	
<p>► <b>Seat and Back Upholstery</b></p> <ul style="list-style-type: none"> <li>Inspect for rips or sagging.</li> <li>Inspect fastening flaps to ensure they securely latch</li> </ul>	✓ ✓		✓	✓
<p>► <b>Rear Wheels</b></p> <ul style="list-style-type: none"> <li>Adjustable Axle Position Camber Bar is securely tightened.</li> <li>Quick/Quad release axles lock properly</li> <li>No excessive side movement or binding when lifted and spun.</li> </ul>	✓ ✓ ✓	✓	✓	✓ ✓
<p>► <b>Handrims</b></p> <ul style="list-style-type: none"> <li>Inspect for signs of rough edges or peeling.</li> </ul>	✓			✓
<p>► <b>Spokes</b></p> <ul style="list-style-type: none"> <li>Inspect for bent or broken spokes.</li> <li>All spokes uniformly tight.</li> </ul>	✓ ✓		✓ ✓	
<p>► <b>Front Castor</b></p> <ul style="list-style-type: none"> <li>Inspect wheel/fork assembly for proper tension by spinning castor; castor should come to gradual stop.</li> <li>Loosen / tighten locknut if wheel wobbles noticeably or binds to a stop.</li> <li>Wheel bearings are clean and free of moisture.</li> </ul> <p>CAUTION: As with any vehicle, the wheels and tyres should be checked periodically for cracks and wear, and should be replaced when necessary.</p>	✓ ✓ ✓	✓ ✓	✓	✓
<p>► <b>Tyres</b></p> <ul style="list-style-type: none"> <li>Inspect for flat spots and wear</li> <li>If pneumatic tyres check for proper inflation.</li> </ul> <p>CAUTION: As with any vehicle, the wheels and tyres should be checked periodically for cracks and wear, and should be replaced when necessary.</p>	✓ ✓	✓ ✓		
<p>► <b>Cleaning</b></p>	✓		✓	

# Troubleshooting Guide

## Mechanical

Chair veers right	Chair veers left	Sluggish turn or performance	Castor flutters	Squeaks and rattles	Loose-ness in chair	Solutions
✓	✓	✓	✓			Check tyres for correct and equal pressure
		✓	✓	✓	✓	Check for loose castor stem nuts Check all fixtures are secure and tight.
				✓	✓	Check spokes and nipples for tension
✓	✓		✓			Check that both castors contact the ground at the same time

### WARNING

After making adjustments, always make sure that parts are properly tightened BEFORE using the wheelchair.

DO NOT over-tighten hardware attaching to the frame. This could cause damage to the frame tubing.

### ► Suggested Maintenance Procedures

1. Before using your RGK Wheelchair, make sure all nuts and bolts are tight. Check all parts for damage or wear and replace. Check all parts for proper adjustment.
2. Keep quick / quad-release axles free of dirt to ensure positive locking and proper operation. Refer to adjusting the quick-release axle or adjusting the quad-release axle in Procedure 3 of this manual.
3. Clean and polish Quick-Release Axles once a month – DO NOT OIL.
4. Recommended tyre pressure is listed on the side wall of the tyre.
5. The wheels and tyres should be checked periodically for cracks and wear, and should be replaced when necessary at your authorised dealer.
6. Regularly check for loose spokes in the rear wheels. If loose, have them adjusted at your authorised dealer.
7. Periodically check handrims to ensure they are secured to the rear wheels. Refer to handrim replacement in procedure 5 of this manual.
8. Periodically adjust wheel locks in correlation to tyre wear. Refer to adjusting wheel locks in procedure 8 of this manual.
9. Periodically check castor wheel bearings to make sure they are clean and free from moisture. Refer to replacing your front castor wheels in procedure 7 of this manual.
10. Check upholstery for sagging, rips or tears. Adjust or replace as necessary
11. The seat upholstery is secured by means of Velcro straps around the frame. The upholstery can easily be removed from the frame by loosening the straps under the seat. Refer to placing your seat upholstery see procedure 2 of this manual.
12. The backrest upholstery is removed by loosening the cover, detaching the centre pad and wings, Refer to adjusting / replacing your upholstery see procedure 1.
13. Wipe down the seat and backrest upholstery with a clean damp cloth. It is important to keep the wheelchair clean, both for your own comfort and longevity of the chair. Clean the frame with a non-abrasive cleaning agent.

#### WARNING

Do not use the wheelchair unless it has the proper tyre pressure (P.S.I). DO NOT over inflate the tyres. Failure to follow these suggestions may cause the tyre to explode and cause bodily harm.

# Procedure 1

This Procedure includes the following:  
Adjusting / Replacing the Back Upholstery

The backrest upholstery is individually adjustable by adjusting either the Velcro straps or Velcro securing wings located under the centre pad.

## ► Adjusting / replacing the back upholstery

To remove back upholstery, remove cushion, release backrest tail from seat sling, release side securing straps and lift upholstery squarely off. To re-fit reverse above procedure. See Fig 14.

Fig 14

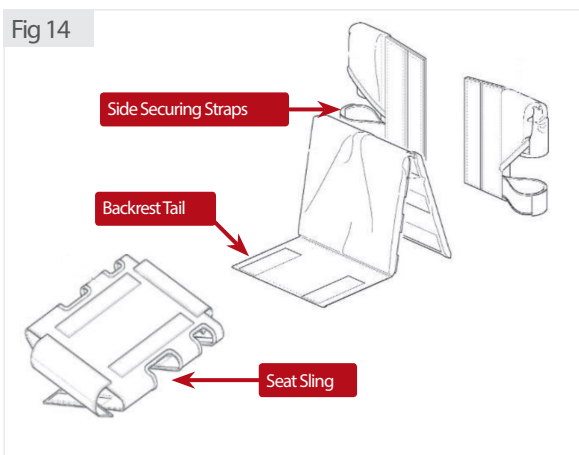

### ⚠ WARNING

The position of the footrest, camber tube and rear seat height, as well as the tautness of the back upholstery are directly related to the chairs stability. Any change to one or any combination of the four may cause the chair to decrease in stability. Use **EXTREME** caution when using a new seating position for the first time.

To adjust tension, pull centre pad up from the rear (side with RGK logo) Re-position side wings to increase/decrease tension and securely re-fit centre pad see fig 15.

With strap adjustable backrest upholstery use straps to decrease/increase tension (not illustrated).

Fig 15

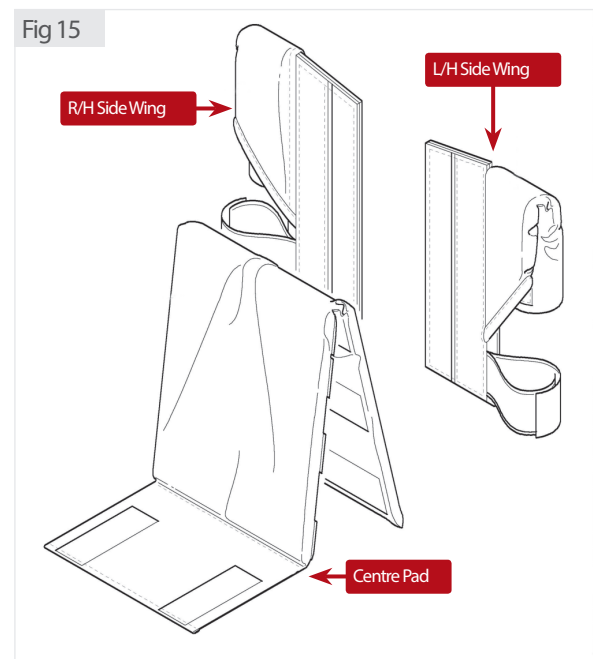

# Procedure 2

This Procedure includes the following:  
Replacing the Seat Upholstery

## ► Seat Upholstery Replacement

1. Remove the seat cushion and back upholstery tail from the seat sling. See Fig 14.
2. Remove rear wheels from chair.
3. Unlatch the fastening flaps that secure the seat upholstery to the chair frame. See Fig 16.
4. Remove the existing seat upholstery, by peeling apart the velcro straps.
5. Install the NEW seat upholstery making sure the fastening flaps hang over the right and left sides of the chair frame.
6. Place the front fastening flaps in front of the cross frame bar and securely latch together.
7. Securely latch the remaining fastening flaps together.
8. Refit rear wheels. See procedure 3
9. Reinstall the back upholstery and seat cushion onto the chair. Refer to adjusting the back upholstery in procedure 1 of this manual.

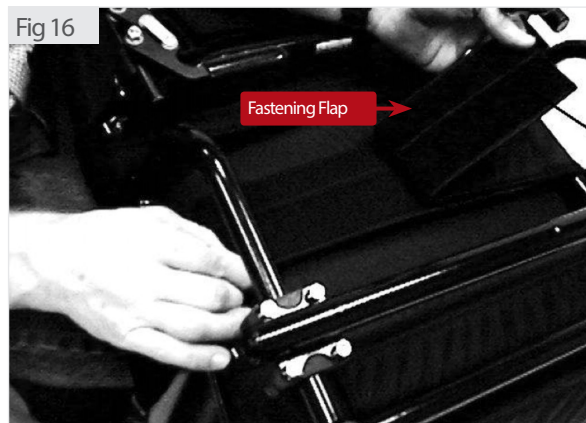
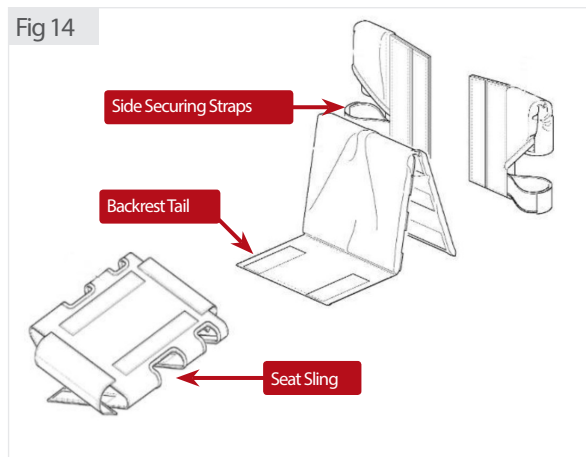



# Procedure 3

This Procedure includes the following:

Removing rear wheels and attaching them to and from your wheelchair.

The wheels can, therefore, be installed or removed without using tools.

## ► Removing rear wheels and attaching them to and from your wheelchair.

1. Push in the detent/RGK button of the quick-release axle. Pull both axle and wheel away from your wheelchair. See figure 17.
2. Repeat STEP 1 for the opposite wheel
3. To reinstall the rear wheels onto your wheelchair. Push in the detent/RGK button of the quick-release axle and insert quick release axle into the camber bar. Pushing both axle and wheel towards your wheelchair



## ⚠ WARNING

Changing the size of your rear wheels can affect the performance of the wheelchair. Please contact RGK Wheelchairs Ltd, numbers located on the back of this manual before changing rear wheel size.

## ► NOTE

Pull on the rear wheels to make sure the detent pin / RGK cap of the quick release axle are fully released before operating the wheelchair.

## ⚠ WARNING

Any adjustments to your quick release pins – then YOU must ensure your wheels lock on both sides of your wheelchair.

When attaching the rear wheels, always check that they are securely mounted. Pull on the rear wheels to make sure the detent pin/RGK cap of the quick release axle are fully released before operating the wheelchair.

You should NOT be able to pull the rear wheel off.

# Procedure 4

This Procedure includes the following:  
Adjusting the Quick-Release Axle

## ► Adjusting the Quick-Release Axle

1. Remove rear wheel and quick-release axle from the chair.
2. Remove quick release axle from the wheel by depressing detent pin/RGK button in the quick-release axle and slide axle through the wheel hub. See Fig 18.
4. Release detent pin/RGK button ensuring that the locking pins are fully released. Increase or decrease end play by adjusting the locknut on the end of the quick-release axle. See Fig 18.
5. Reinstall rear wheel onto the chair.

### ► NOTE

Please note the quick release axle is removable and can be adjusted in length.

Fig 18

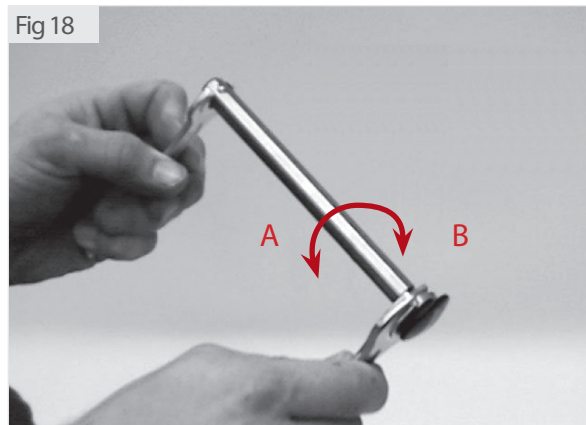

A = Lengthen B = Shorten

### ⚠ WARNING

Any adjustments to your quick release pins – then YOU must ensure your wheels lock on both sides of your wheelchair.

When attaching the rear wheels, always check that they are securely mounted. Pull on the rear wheels to make sure the detent pin / RGK cap of the quick release axle are fully released before operating the wheelchair.

You should NOT be able to pull the rear wheel off.

# Procedure 5

This procedure includes the following:  
Replacing the Hand Rim; Repairing/Replacing rear wheel, tyre/tube;

## ⚠ WARNING

If a handrim should become damaged it could lead to injury, and should be replaced.

### ► Handrim replacement

1. Remove the rear wheel from the chair by depressing the detent/RGK button.
2. Remove all air from the tube by pressing down on the pin in the centre of the valve stem
3. While carefully holding the tyre, tube and rim strip to one side, hold the allen head screws and remove the locknuts that secure the handrim to the rear wheel.
4. Remove the existing handrim.
5. Install the NEW handrim by reversing the above procedures.
6. Inflate the tyre to the correct psi rating on the sidewall of the tyre.
7. Reinstall rear wheel to the chair.
8. Repeat the procedure for the opposite rear wheel if necessary.

### ► NOTE

It is not necessary to remove tyre and tube when replacing hand rim on either Spider or X-Core Wheels.

### ► Repairing / replacing rear wheel, tyre & tube

1. Remove the rear wheel from the chair..
2. Remove all air from the tube by pressing down on the pin in the centre of the valve stem.
3. Unscrew the valve securing ring (Presta valves only). Using tyre levers, remove outside tyre bead from wheel rim, unscrew valve securing ring (Presta valves only) remove tube. Remove tyre from rim. Reverse procedure to fit tyre/tube.
4. Inflate the tyre to the correct psi rating on the side wall of the tyre.
5. Reinstall rear wheel to the chair.
6. Repeat the procedure for the opposite rear wheel if necessary.

### ► NOTE:

If replacing the rear wheels or tyres with a different size than what was originally on the chair please note this will raise or lower the rear of the chair and may have an adverse effect on your balance.

Please contact your dealer or mobility advisor for additional advice.

## ⚠ WARNING

Tyre **MUST** be deflated before any disassembly procedures are performed.

## ⚠ WARNING

DO NOT inflate tyre until it is completely assembled.

## ⚠ WARNING

Make sure the detent/RGK button of the quick release axle is fully released **BEFORE** operating the wheelchair.

# Procedure 6

This procedure includes the following:  
Adjusting or Replacing your camber bar

## ► Adjusting / replacing the camber bar

This procedure applies to either 2 fixing requires a 8mm allen key (see fig. 19) or 4 fixing requires a 5mm allen key (see fig. 20) mounting system

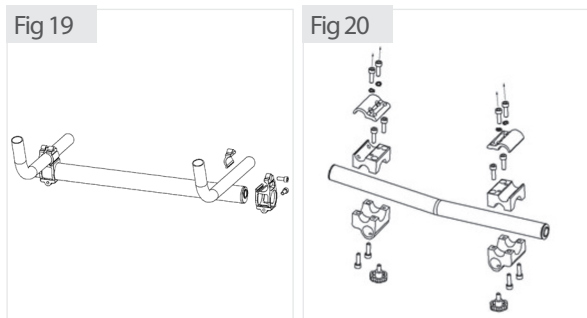

1. Remove the rear wheels from the chair.  
(As procedure 3)
2. Loosen the allen head screws that secure the adjustable axle position camber bar to the chair frame.

### ► NOTE:

Ensure the allen head screws are loose enough to allow the adjustable axle position camber bar to move freely along the chair frame to avoid scratching the chair frame.

3. Move the adjustable axle position camber bar forward or back along the chair frame to adjust. Lengthening the wheelbase will increase the stability and maintain standard manoeuvrability of the chair. Shortening the wheelbase will increase the manoeuvrability and distribute additional weight onto the rear wheels.
4. Measure both attaching points of the adjustable axle position camber bar from the both back posts to ensure the adjustable axle position camber bar is positioned at a 90° angle to the chair frame. See fig. 10 C-D.
5. Securely tighten the allen head screws that secure the adjustable axle position camber bar to the chair frame.
6. Reinstall the rear wheels onto the chair.
7. Roll the chair before using to make sure there is

no excessive drag to either side.

### ► NOTE:

If drag to either side occurs, repeat the above procedures until the chair rolls correctly.

### ⚠ WARNING

Tyre **MUST** be deflated before any disassembly procedures are performed.

### ⚠ WARNING

**DO NOT** inflate tyre until it is completely assembled.

### ⚠ WARNING

Make sure the detent pin of the quick/quad release axle is fully released **BEFORE** operating the wheelchair.

### ⚠ WARNING

The position of the footrest, camber tube, as well as the tautness of the back upholstery, are directly related to the chairs stability. Any change to one or any combination of the three may cause the chair to decrease in stability. Use **EXTREME** caution when using a new seating position for the first time.

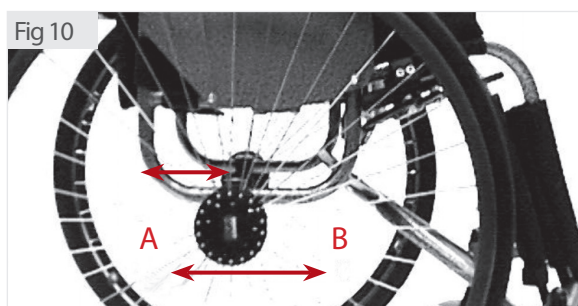

A = Rearward / Lengthen  
B = Forward / Shorten

# Procedure 7

This procedure includes the following:

## Replacing the Front Castor Fork assembly, Castor Wheels & Frame Bearings

### ► Replacing Fork Assembly

1. Remove cap Fig 21.
2. Remove the bolt and locknut that secure the front fork assembly.
3. Remove the front castor fork assembly using 19mm socket spanner downwards through the castor housing noting any washer sequence.
4. Install the NEW front castor fork and reverse steps 2 - 1 to refit.
5. Repeat the procedure for the opposite front castor if necessary.

### ► Replacing Front Castor Wheels

1. Using two 4mm Allen keys, remove 1 of the 2 screws that locate the castor axle.
2. Remove the castor axle by sliding it out. Remove the castor wheel and spacers from the castor fork.
3. Install the NEW castor wheel, castor axle and spacers to the castor fork, by reversing STEPS 1 & 2.

Fig 21

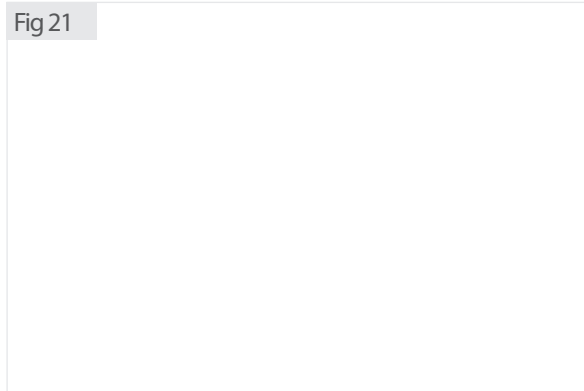

# Procedure 7

This procedure includes the following:

## Replacing the Front Castor Fork assembly, Castor Wheels & Frame Bearings

### ► Replacing Bearing in the Frame

1. Remove castor pot cap.
2. Remove nut on top of castor pot, using a 19mm socket spanner.
3. Remove castor assembly downwards through the castor housing noting any washer sequence.
4. Carefully, knock out the bearings using a punch and a hammer
5. Insert NEW bearings using a bearing puller / pusher
6. Reinstall the castor fork by reversing STEPS 3, 2 & 1

### ⚠ WARNING

Bearings must be fitted using the correct tool. Failure to use the correct tool may result in reduced performance, personnel injury or property damage.

### ► NOTE:

RGK DO NOT recommend replacing the front castor forks or castor wheels with a different size other than what was originally supplied on the chair.

By changing to a different size castor fork or castor wheel will have an adverse effect on the running of the chair and the end users balance.



# Procedure 8

This procedure includes the following:  
Adjusting / Replacing Wheel Locks

► **NOTE:**

Before adjusting or replacing any style of wheel lock ensure that the tyres are inflated to the recommended pressure as indicated on the tyre.

► **Wheel Locks - Adjustment / Replacement**

1. To replace push/pull wheel lock: See Fig 23.  
Loosen the two allen head screws in the clamp which secure the wheel lock to the frame. Slide wheel lock out of clamp. Fit new wheel lock by reversing procedure.
2. To replace under seat scissor lock: Use same procedure as push/pull lock. See Fig 24.
3. Adjustment - All wheel lock styles:
- 4 The wheel lock tyre pressure bar should embed by 5-7mm into the (pneumatic) tyre when engaged. Adjust to give satisfactory locking of the chair wheels.

⚠ **WARNING**

After any adjustments, repair or service and before use, make sure all attaching hardware is tightened securely – otherwise injury or damaged may result.

⚠ **WARNING**

If wheel locks do not hold occupied wheelchair in place please adjust as above, or contact your dealer – otherwise injury or damages may occur.

⚠ **WARNING**

The wheel locks are designed to work when your wheelchair is static. Wheel locks should not be applied during use.



# Procedure 9

This Procedure includes the following:  
Adjusting the footrest height / angle, and replacing the footrest.

## ► Adjusting / replacing the footrest

1. Loosen the two allen head screws that secure the footrest to the chair frame. (Located at the rear of the frame see Fig 25)
2. Remove footrest – ensuring the footrest is removed with equal pressure.
3. Remove existing and install NEW footrest.
4. Position the NEW / existing footrest to a determined height.
5. Tighten the two allen head screws “A” that secure the footrest to the chair frame. See Fig 25.

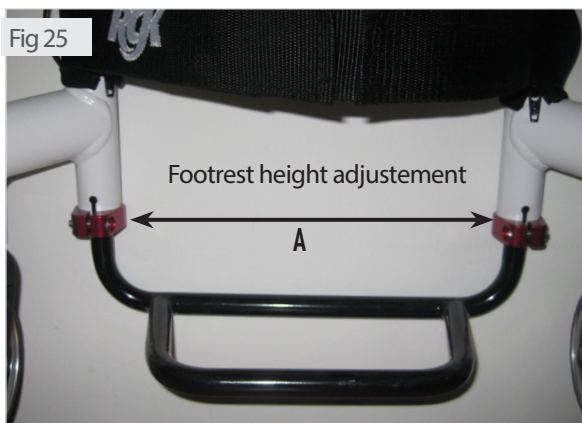

### ⚠ WARNING

The position of the footrest, camber tube and rear seat height, as well as the tautness of the back upholstery are directly related to the chairs stability. Any change to one or any combination of the four may cause the chair to decrease in stability. Use EXTREME caution when using a new seating position for the first time.

## ► Angle adjusting the footrest platform

1. To adjust the angle on your angle adjustable footrest. Loosen two button head allen screws “A” (see fig 26) on top of foot platform.
2. Rotate until desired angle is achieved.
3. Securely tighten two button head allen screws.

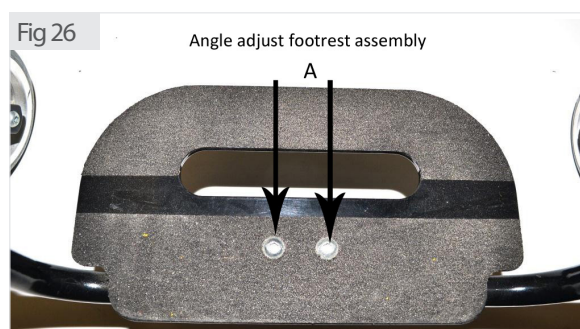

### ⚠ WARNING

The footrest assembly MUST be at least 40mm above the ground/floor to avoid hitting protruding objects when using this wheelchair.

### ⚠ WARNING

Do not stand on the footrest/footplate! Even if the user is sitting in the chair, there is still a risk of tipping over and injury.

### ⚠ WARNING

When transferring, do not stand on the footboard, there is a risk of tipping over and injury.

# Procedure 10

This Procedure includes the following:  
Unfolding / Folding the backrest.

## ⚠ WARNING

Your folding back **MUST** be locked securely in place before using your wheelchair.

### ► Folding your backrest with cord support

1. To fold the backrest, grasp cord support as fig 27.
2. Pull the cord strap towards the brace bar as fig 28 this will release both locking pins, allowing the backrest to fall forward.
3. Push the backrest firmly down ensuring that the pins locate in the locking holes.
4. To unfold the backrest, reversing STEPS 1, 2 & 3 – Ensure that the locking pins are secure and located in the pivot plate.

Fig 27



Fig 28



Fig 29



# Procedure 10

This Procedure includes the following:  
Unfolding / Folding the backrest.

## ► Folding your backrest with a webbing support strap

1. To fold the backrest, grasp the webbing cord in a fist like manner (see Fig 30)
2. Twist 90 degrees' this will apply equal pressure to left and right release pins. (See fig 30 allowing the backrest to fall down.
3. Push the backrest firmly down ensuring that the pins locate in the locking holes.
4. To unfold the backrest, reversing STEPS 1, 2 & 3 – Ensure that the locking pins are secure and located in the pivot plate.

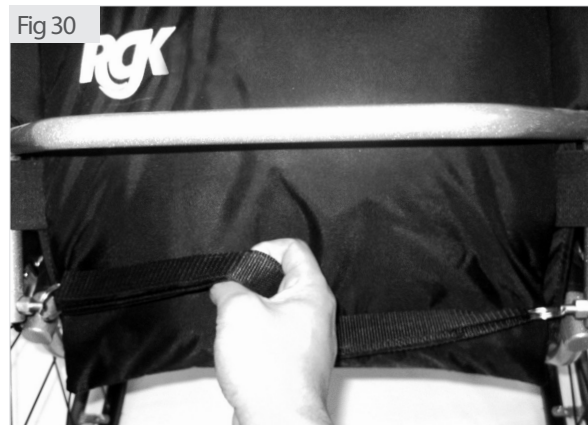

## ► NOTE:

The wheelchair shown and described in this user guide may not correspond in every detail exactly.

# Procedure 11

This Procedure includes the following:  
Height adjustable pushing handles, Fold-down push handles.

## ⚠ WARNING

DO NOT attempt to lift the wheelchair by any removable (detachable) parts.

This includes Height adjustable pushing handles, Fold-down push handles & Screw in Push handles

Lifting by means of any removable (detachable) parts of a wheelchair may result in injury to you the assistants and damage your wheelchair.

## ► Height adjustable push handles

1. To operate this style of pushing handle open the mini quick release lever as indicated (fig 31). By opening the quick release lever allows the stroller handle to be adjusted in height.
2. Once the desired height is achieved then close the mini lever.
3. If the lever becomes loose, then the nut on the mini release lever requires tightening. (The nut on the mini release lever determines on how tightly the clamp is applied)



## ► Flip-down push handles

To fold down your pushing handles, depress the button (2) when required again, simply lift back into position and lock. See Fig 32.



## ► Screw in Pushing Handles

These are screwed into position by turning the handle clock wise, and anti clockwise to remove. See Fig. 33.





# Procedure 12

This Procedure includes the following:  
Adjusting the Anti-Tipper.

► **NOTE:**

Anti-tippers **MUST** be fully engaged. Ensure the release button of the anti-tipper fully protrudes out of the hole in the anti-tipper socket.

Ensure both anti-tippers are adjusted to the same height.

► **Adjusting the Anti-tipper**

1. Press in the release buttons that secures the anti-tipper wheel to the anti-tipper bar.
2. Adjust the height of the anti-tipper wheels to between 25mm and 50mm of the ground.
3. Repeat steps 1 – 2 for the opposite anti-tipper.

⚠ **WARNING**

Anti-tippers are an option on this wheelchair (you may have ordered it with or without anti-tippers). RGK strongly recommends that ordering the anti-tips as an additional safeguard for the wheelchair user

Fig 29



Fig 30





# Procedure 13

This Procedure includes the following:  
Sideguards and Armrest

## ► Fixed Sideguards (All Materials)

The sideguard is fitted by means of either 3/4/5/6 screws dependant on the configuration of your wheelchair

Fig 31



## ► Height Adjustable Armrest Height Adjustment

- 1 Rotate height release lever (2) to the second position.
- 2 Slide the armrest pad up or down to the required height.
3. Return the lever to the locked position against the armrest
- 4 Push the arm pad until the upper arm post locks firmly into place.

Fig 32



### ⚠ WARNING

RGK Wheelchairs DOES NOT encourage the transportation of any person in a vehicle using a lapbelt/strap as a method of restraint. The end user should be transferred into the vehicle seating system and restraints.

# Procedure 14

This procedure include the following:  
Strapping:

## ► Location of the strapping

The strap can positioned either, under the wheelchair and passing up between the side guards (if fitted) and fastened across the lap or pelvis. Other option is passing around the back and inserted in between the insides of the centre pad as per Fig 33

This style of strap is a positioning strap only.

## ⚠ WARNING

It is not designed for use as a safety device to withstanding high stress loads such as auto safety belts.

With regards to chest positioning straps – it is the obligation of the therapists and other healthcare professionals to determine if a chest strap/harness is required.

Fig 33



# Technical Data

	From	Max
Overall Width	250 cm	500 cm
Overall Seat Height	300 cm	600 cm
Overall Length	400 cm	800 cm
Weight in Kg	From 6.4Kg	125Kg

► Please note

RGK Wheelchairs Ltd are bespoke and individually made for you, therefore your wheelchair may fall below or over the above mentioned sizes

## Torque

Backrest Pivot Plate	5Nm
Wheel Lock	5Nm
Camber Bar	5Nm
Footrest Adjustment Height	7Nm
All other items	5Nm

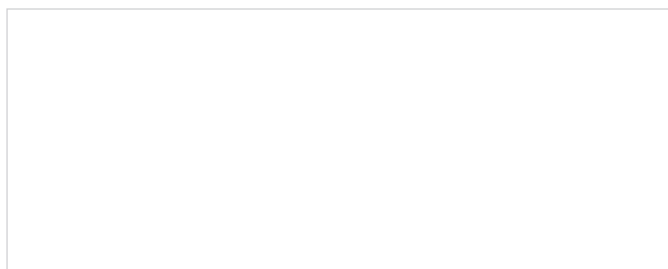

## ► Recycling/Disposal

Prior to the wheelchair being re-used, it must be carefully prepared. All surfaces which come into contact with the user must be cleaned down and treated with a disinfection spray.

In the following section, there is a description of the materials used on our wheelchairs.

► **Aluminum:** Castor forks, Wheels, side guards, Armrest, Footrest, Hand Rims, Anti-Tippers, Frame, Footplate covers

► **Steel:** Fixing points, Quick release axle pins, Footrest, Anti-tippers, Frame Wheels, Fixings, Wheel Locks, Footplate covers

► **Titanium:** Castor Forks, Quick release axle, Fixings, Side guards Anti-Tippers, Frame, Footrest

► **Plastic:** Handles, Tube stoppers, Castors, Footplate covers, Arm pads

► **Packing:** Plastic bags made from polyethylene, cardboard

► **Upholstery:** Woven polyester Cotton Leather



Disposal or recycling should be carried out by a disposal company or at a public disposal point. You could also return your wheelchair to your dealer for disposal (There may be a charge imposed).

# Warranty

► **Product Grouping**

TIGA

► **Warranty**

This warranty is extended only to the named purchaser/user of the product. This warranty gives you specific legal rights and you may also have other legal rights. RGK warrants the main frame to be free from defects in materials and workmanship for a period of 5 years of the original purchaser/user from the date of purchase from RGK Wheelchairs Ltd or a dealer with a copy of the invoice required for coverage under this warranty.

All Integrated/welded components parts included, but limited to:

- Integrated/welded camber bars
- Integrated/welded side guards
- Integrated/welded footrest
- Integrated pushing handles

Are supplied with a 5 year warranty.

All component parts including, but not limited to:

- camber tubes
- folding backrest
- pushing handles
- castor forks
- anti-tippers
- sideguards & armrests
- wheel components
- upholstery and strapping
- wheel locks are supplied with 12 month warranty.

All component parts including, but not limited to:

- bushings and bearings
- tyres and inner tubes
- Adjustable height footrest, if 3rd party devices are fitted. i.e. Free Wheel
- push handle grips, foam parts and plastic/ rubber coated parts are supplied without warranty.

All components parts included, but not limited to:

- Other 3rd part supplied equipment, either powered assist, propulsion systems, specialist cushions will be referred back to the manufactures warranty period.

► **Expectation**

If within the stated warranty period and such product shall be proven to be defective, such product shall be repaired or replaced at RGK's option and cost. This warranty does not include any third party labour or shipping charges incurred in the repair or replacement of any such product. RGK'S sole obligation and your exclusive remedy under this warranty shall be limited to such repair or replacement.

► **Contact**

For warranty service, please contact the dealer from whom you purchased your RGK product. In the event you do not receive satisfactory warranty service, please contact RGK directly by the methods shown below. Provide the dealer's name, address and the date of purchase, indicate nature of the defect and, if the product is serialized, indicate the serial number. Do not return products to our factory without our prior consent.

► **Limitations and Exclusions**

The foregoing warranty shall not apply to serial numbered products if the serial number has been removed or defaced, products subjected to negligence, accident, improper operation, maintenance or storage, commercial or institutional use, products modified without RGK'S express written consent, including, but not limited to:

- modification through the use of unauthorized parts or attachments

- products damaged by reason of repairs made to any component without the specific consent of RGK

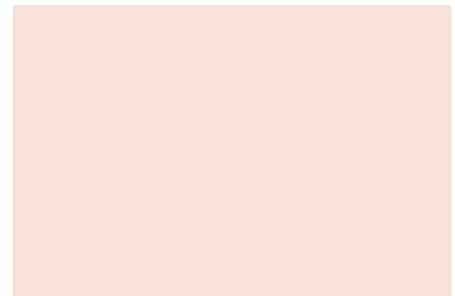

Please make a reference of your chair model and serial number (found on sticker on your camber bar) and quote this whenever calling the office regarding your chair. For example if you would like to order replacement parts; we will be able to find out the ones you have and also alternatives that fit your chair.

Chair Model:	Serial No:

## Head office address...

Unit 8 A/B/C Ring Road Zone 2,  
Burntwood Industrial Estate,  
Burntwood, Staffordshire, WS7 3JQ

- ▶ Call: +44(0)1543 670 077
- ▶ Fax: +44(0)1543 670 088
- ▶ Email: [info@rgklife.com](mailto:info@rgklife.com)