

RGK Head Office: Units 8 A/C Ring Road, Zone 2, Burntwood Business Park, Burntwood, Staffordshire, WS7 3JQ, UK
 Telephone:+44 (0) 1543 670077 - Fax:+44(0)1543 670088 - info@rgkwheelchairs.com - www.rgkwheelchairs.com

To place order: chairorders@rgkwheelchairs.com

To request quotation: quotes@rgkwheelchairs.com



Distributor Name: _____
 Contact Name: _____

Purchase Order No: _____
 Delivery Address: _____

 Postcode: _____
 Contact Name: _____
 Telephone: _____
 Email: _____

Notes/Comments:

FOR RGK OFFICE USE ONLY

A/C No: _____		
	Who	Date
OK to Quote:		
OK to Confirm:		
Document No:	DOC	

Net Value:	€ _____
Freight:	€ _____
Invoice Value:	€ _____
Payment Received:	€ _____

- | | | |
|--|--|---|
| <input checked="" type="checkbox"/> Base Product | Mandatory Information | Information Required for Option |
| <input checked="" type="checkbox"/> Standard Configuration | <input type="checkbox"/> Option with No extra cost | <input type="checkbox"/> Option with Extra cost |

CMSXZ011 CHROME
€ 3,093.00

- XA070 Open design
- XA080 Closed design (25mm seatrail tube)
- XA081 Closed design (19mm seatrail tube)

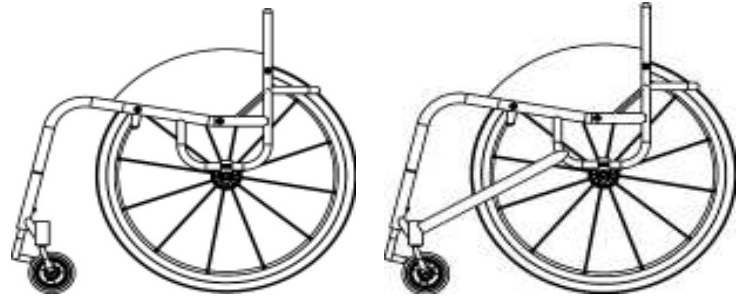

Max User Weight 125kg

- XW010 Full CAD drawing for approval
€ 173.00
- XW011 Quick CAD drawing for approval
€ 112.00 (Basic outline of chair within 2 working days*) *Approximate time only

KEY FRAME MEASUREMENTS

- XY010 Seat width (*Inside of sideguards*)
- (Max - 550mm)
(Min - 250mm)
- XY020 Seat length
- (Max - 550mm)
(Min - 250mm)
- XY030 Extra seat length (*Provides additional leg support & hand grip*)
-
- XY050 Front frame height
- (Max - 550mm)
(Min - 380mm)
- XY060 Rear frame height
- (Max - 550mm)
(Min - 360mm)
- XY070 Frame length
- (Min XY020 + XY030 + 110mm)
- XY072 Castor position
-
- Optimise measurements*

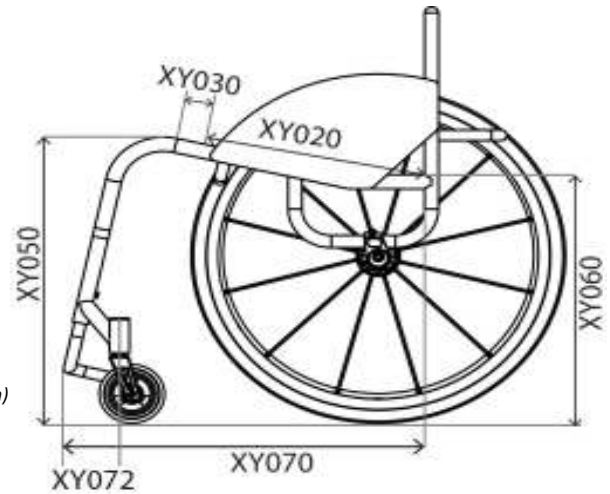

- XA020 Ergonomic seat
€ 83.00
- Specify length (Standard = 120mm)

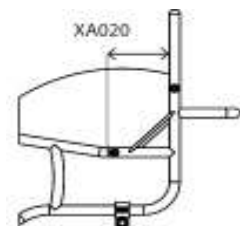

FRONT FRAME AND FOOTREST

Front Frame Options

- XY085 Seat taper design
€ 83.00

Specify width

mm

(When combined with XY091, dimension is inbetween the centre of the main bends)



- XY091 Parallel taper design

Specify width

mm

(When combined with XY085, Dimensions must be smaller)



Footrest Design (Choose One)

- XY100 Round design

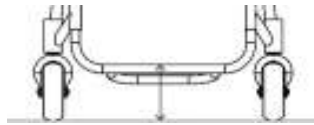

- XY105 Square design

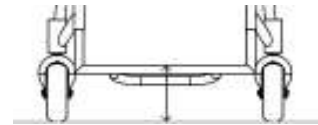

- XB200 High level footrest (Only with XB010, CMSXB080 & XB150)
€ 146.00

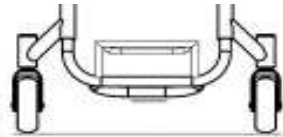

- XB200 High level footrest (Only with XB010, CMSXB080 & XB150)
€ 146.00

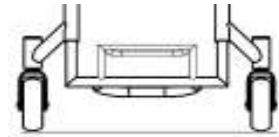

Footrest Individual Measurements

- XY115 Front footrest height



mm

- XY120 Rear footrest height



mm

(Std = 20 lower than front height)

- XY125 Footrest length



mm

(Std = 100mm)

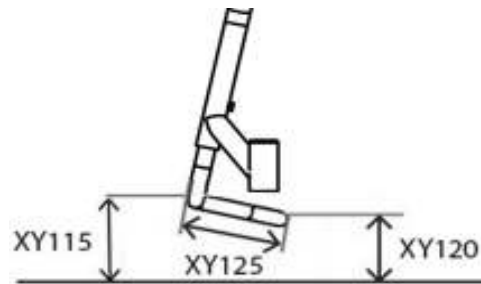

Footrest Style (Choose One)

- XB010 Tubular aluminium footrest (Height adjustable)

- XB070 Angle adjust aluminium footrest (Angle/height adjustable)
€ 117.00

- CMSXB080 Tubular footrest welded into frame (No height adjustment)
€ 132.00

- XB030 Flip up plastic footrest (Angle/height adjustable) (with closed frame only)
€ 279.00

- XB150 Heavy duty tubular footrest (Height adjustable)
€ 146.00

Footrest Cover

- XB050 Carbon fibre cover (Not XB070 & XY030)
€ 138.00

- XB040 Plastic Cover (Not XB070 & XY030)
€ 71.00

- XB170 Aluminium cover (Not XB070 & XB030)
€ 71.00

- XB165 Rubber grip tape (3M Safety walk)(not with XB030)
€ 39.00

CASTOR WHEELS, FORKS & WHEEL LOCKS

Castor Wheels

3"

- XC150 Froglegs Aluminium centre 3"x1.4"
€ 132.00 (Silver hub and black urethane tyre)

4"

- XC060 Soft roll 4"x1.3"
(Black)
- XC110 Froglegs Aluminium centre 4"x1"
€ 132.00 (Silver hub and black urethane tyre)
- XC130 Froglegs Aluminium centre 4"x1.4"
€ 132.00 (choose colour below)



- | | | | |
|--|--|--|---|
| <input type="checkbox"/> Silver hub & black tyre (Std) | <input type="checkbox"/> Black hub & blue tyre | <input type="checkbox"/> Purple hub & black tyre | <input type="checkbox"/> Silver hub & blue tyre |
| <input type="checkbox"/> Black hub & black tyre | <input type="checkbox"/> Red hub & black tyre | <input type="checkbox"/> Gold hub & black tyre | <input type="checkbox"/> Silver hub & red tyre |
| <input type="checkbox"/> Black hub & red tyre | <input type="checkbox"/> Blue hub & black tyre | <input type="checkbox"/> Green hub & black tyre | |

5"

- | | |
|---|--|
| <input type="checkbox"/> XC070 Soft roll 5"x1.3"
(Black) | <input type="radio"/> XC120 Froglegs Aluminium centre 5"x1"
€ 132.00 (Silver hub and black urethane tyre) |
| <input type="radio"/> XC100 Pneumatic Aluminium centre 5"x1"
€ 148.00 (Grey) | <input type="radio"/> XC140 Froglegs Aluminium centre 5"x1.4"
€ 132.00 (Silver hub and black urethane tyre) |

6"

- XC145 Frog Legs aluminium centre 6"x1.4"
€ 132.00 (Silver hub and black urethane tyre)

Castor Forks

- | | |
|--|--|
| <input type="checkbox"/> CMSXC240 Extruded aluminium castor fork
(Standard when no option selected) | <input type="radio"/> XC210 Froglegs suspension castor
€ 482.00 fork |
| <input type="checkbox"/> CMSXC190 Low ride castor fork
€ 87.00 | <input type="radio"/> XC250 Welded steel castor fork (Heavy duty)
€ 87.00 |
- Black only Black Silver
 Black Silver Black only

Castor Pin Width

- XY330 Castor pin width
- mm
 Optimise measurements
 (Minimum width for clear castor rotation and maximum wheelbase length)



Wheel Lock Options (Choose one)

- | | |
|---|--|
| <input type="checkbox"/> XD020 Underseat Scissor | <input type="checkbox"/> XD050 Push to lock |
| <input type="radio"/> XD030 Compact scissor
€ 104.00 | <input type="radio"/> XD046 Out Front push to lock
€ 179.00 |
| <input type="radio"/> XD035 Compact scissor with lightweight fixing
€ 123.00 (Only with fixed centre of gravity) | <input type="checkbox"/> XD010 Omit wheel locks |
| <input type="radio"/> XD045 Out Front Compact scissor
€ 179.00 | |

Choose one castor option only

SIDEGUARDS AND ARMRESTS

Sideguard		Sideguard with Fender	
Aluminium Options		Aluminium Options	
<input type="radio"/>	XE030 Screw on aluminium € 184.00	<input type="radio"/>	XE040 Screw on aluminium with fender € 220.00
<input type="radio"/>	XE080 Lift out aluminium € 423.00	<input type="radio"/>	XE090 Lift out aluminium with fender € 459.00
<input type="radio"/>	XE180 Flip back aluminium € 220.00	<input type="radio"/>	XE190 Flip back aluminium with fender € 255.00
Carbon Fibre Options		Carbon Fibre Options	
<input type="radio"/>	XE050 Screw on carbon fibre € 411.00	<input type="radio"/>	XE060 Screw on carbon fibre with fender € 540.00
<input type="radio"/>	XE100 Lift out carbon fibre € 573.00	<input type="radio"/>	XE110 Lift out carbon fibre with fender € 667.00
<input type="radio"/>	XE200 Flip back carbon fibre € 445.00	<input type="radio"/>	XE210 Flip back carbon fibre with fender € 540.00
ABS Plastic Options		Sideguard Measurements	
<input type="radio"/>	XE070 Screw on ABS plastic € 184.00	Fender height	
<input type="radio"/>	XE120 Lift out ABS plastic € 275.00	<input type="checkbox"/>	10mm above tyre <i>(Standard)</i>
Welded Options		<input type="checkbox"/>	Individual above tyre <i>(Min = 10mm)</i>
<input type="radio"/>	CMSXE220 Welded with 6mm bead € 391.00	<input type="checkbox"/>	mm
<input type="radio"/>	CMSXE240 Welded sport € 503.00 <i>(Extra strong)</i>	<input type="checkbox"/>	mm
Armrest Options		Fender position	
<input type="radio"/>	XF010 Lift out armrest with plastic sideguard € 472.00 <i>(Indicate fixed height)</i>	<input type="checkbox"/>	Centre of tyre <i>(Standard if no option selected)</i>
<input type="radio"/>	XF020 Lift out armrest with Aluminium sideguard € 472.00 <i>(Indicate fixed height)</i>	<input type="checkbox"/>	Outside of tyre
<input type="checkbox"/>	<i>Height (Top of seatrail to top of armrest)</i> mm		
Sideguard Measurements		Choose optimised or individual measurements	
Optimised measurements		Choose optimised or individual measurements	
<input type="checkbox"/>	25mm above tyre <i>(Follow tyre)</i>		
<input type="checkbox"/>	Individual above tyre <i>(Follow tyre)</i>		
<input type="checkbox"/>	Level with tyre <i>(Follow tyre)</i>		
Individual measurements		Choose optimised or individual measurements	
Sideguard length	mm		
Sideguard height	mm		

BACKREST

Backrest Height - Fixed or Adjustable (Choose One)

XY230 Backrest height fixed

Specify height mm

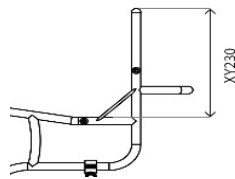

XY245 Adjustable height backrest
€ 138.00 (+/-25mm)

Specify height mm

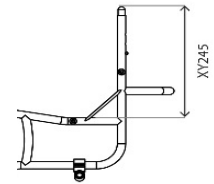

Backrest Design - Fixed or Folding (Choose One)

XG010 Fixed backrest (Non-folding)

CMSXG020 Backrest folding with 2 position snap lock and angle adjust (± 5 Deg)
€ 384.00

Ergonomics - Rearward Positioning (Choose One)

XY360 Backrest angle

-5 -3 0 +3 +5

Individual Deg
(Max -10/+20 Deg)

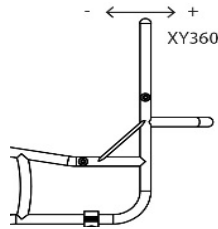

XG100 Ergonomic backrest
€ 83.00

Vertical height mm

Rearward position mm

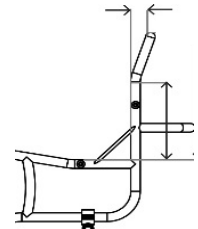

Ergonomics - Lateral Positioning (Choose One)

XG110 Inward taper (inside of backrest posts)
€ 83.00

Specify width or per side mm

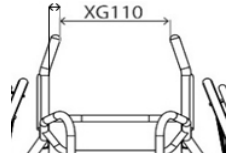

XG120 Outward flare (inside of backrest posts)
€ 83.00

Specify width or per side mm

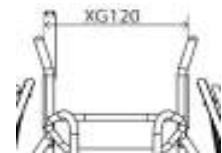

Push handle Options

XG070 Screw in push handles
€ 162.00 (N/A with XY245)

XG090 Stroller push handles height adjustable
€ 287.00

XG080 Flip down push handles
€ 249.00 (N/A with XY245)

Height from floor mm

XG085 Flip down push handles height adjustable
€ 274.00 (N/A with XY245)

Optimise (1000mm from floor)

Backrest Options

XG040 Heavy duty backrest upgrade
€ 148.00 (Recommended for hand cycling) (Not with XY245)

XG130 Extra deep brace bar
€ 83.00 (Recommended for JAY backs) (Std - 90mm)

Depth mm

ILSA Backrest Options

XG140 Integrated lateral support
€ 435.00

A - Left mm

A - Right mm

B - Left mm

B - Right mm

C - Left mm

C - Right mm

D - Left mm

D - Right mm

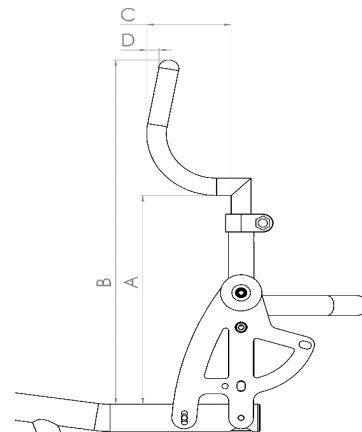

CAMBER BAR

Centre of gravity - Choose one

Adjustable Centre of Gravity

XH110 Square back adjustable centre of gravity
(25-150mm)

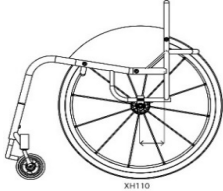

XH120 Round back adjustable centre of gravity
(60-150mm)

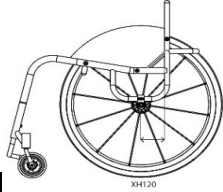

mm

mm

Centre of gravity - Choose one

Fixed Centre of Gravity

CMSXH090 V-style fixed centre of gravity
€ 346.00
(25-125mm)

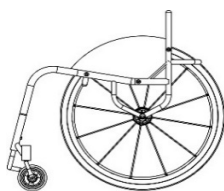

mm

Specify Camber Angle

XY390 Camber angle

deg

Specify Camber Angle

XY390 Camber angle

deg

Camber Bar Options

XH030 Frog Legs suspension camber bar
€ 698.00

XH040 Handbike camber bar fixed
€ 290.00

Camber angle (Handbike camber bar)

0 5

Castor height from floor for handbike fitting
(Standard 30mm if not indicated)

30 50

Camber Bar Options

XH040 Handbike camber bar fixed
€ 290.00

Camber angle (Handbike camber bar)

0 5

Castor height from floor for handbike fitting
(Standard 30mm if not indicated)

30 50

Anti-Tip Options

XJ010 Anti tip swingaway left side (Only with square back frame. Not with XH040)
€ 148.00

XJ020 Anti tip swingaway right side (Only with square back frame. Not with XH040)
€ 148.00

XJ100 Single sport anti tip (centre mounted)
€ 459.00

REAR WHEELS			
Wheel Size			
<input type="checkbox"/> XY420 24" Wheels	<input type="checkbox"/> XY430 25" Wheels	<input type="checkbox"/> XY440 26" Wheels	
Wheel Gap			
<input checked="" type="checkbox"/> XY460 Rear wheel gap <div style="display: flex; align-items: center; margin-top: 5px;"> <div style="text-align: center; margin-right: 10px;"> <input type="checkbox"/> 15 mm </div> <div style="text-align: center; margin-right: 10px;"> <input type="checkbox"/> 20 mm </div> <div style="text-align: center;"> <input type="checkbox"/> 25 mm </div> </div>			
Wheel Options (Choose one)			
<input type="checkbox"/> XK010 Fusion 16 spoke <i>(Silver Hub, black spokes)</i>	<input type="radio"/> XK320 Spinergy XLX 12 spoke, cross/radial spoked € 765.00		
<input type="radio"/> XK050 Spinergy LX 12 spoke € 727.00	<input type="radio"/> XK060 Spinergy SPOX 18 spoke € 547.00		
<input type="radio"/> XK150 Spinergy CLX 18 carbon blade spoke € 1,445.00	<input type="radio"/> XK070 Spinergy BLXL 18 blade spoke € 765.00		
Spinergy Colour Options:			
<input type="checkbox"/> Black / Silver hub	<input type="checkbox"/> White / Black hub	<input type="radio"/> XK180 Custom spoke design € 170.00 <i>(Specify colour)</i> Inside: _____ Outside: _____	
<input type="checkbox"/> Red / Black hub	<input type="checkbox"/> Blue / Black hub		
<input type="checkbox"/> Yellow / Black hub	<input type="checkbox"/> Green / Black hub		
<input type="checkbox"/> Pink / Black hub	<input type="checkbox"/> Orange / Black hub		
<input type="checkbox"/> Purple / Black hub			
Custom Anodise Options			
<input type="radio"/> XK190 Black hub € 89.00	<input type="radio"/> XK200 Silver hub € 89.00	<input type="radio"/> XK201 Red hub/rims € 179.00 <i>(LX, XLX & BLXL only)</i>	
<input type="radio"/> XK202 Purple hub/rims € 179.00 <i>(LX, XLX & BLXL only)</i>	<input type="radio"/> XK203 Blue hub/rims € 179.00 <i>(LX, XLX & BLXL only)</i>	<input type="radio"/> XK204 Custom hub/rims € 236.00 <i>Select colour: _____</i>	
Handrim Position			
<input type="checkbox"/> XY480 Handrim set narrow	<input type="checkbox"/> XY485 Handrim set wide		
<input type="radio"/> XL090 Remove excess mounting tabs € 106.00 <i>(recommended for small wheel gaps)</i>			
Handrim Options			
<input type="checkbox"/> XL010 Aluminium hard anodised 6 tab	<input type="radio"/> XL040 Titanium 6 tab € 251.00		
<input type="radio"/> XL030 Surge LT 6 tab € 354.00	<input type="radio"/> XL050 Stainless steel 6 tab € 138.00		
<input type="radio"/> XL020 Tetra grip 6 tab € 296.00	<input type="radio"/> XL140 Ergo gripp 6 tab wide € 308.00		
<input type="radio"/> XL100 Para grip 6 tab € 296.00			
Tyre Options			
<input type="checkbox"/> XM010 Kenda	<input checked="" type="checkbox"/> Grey <i>(std)</i>	<input type="checkbox"/> Blue	<input type="checkbox"/> Red
<input type="radio"/> XM130 Kenda black € 19.00			
<input type="radio"/> XM020 Schwalbe Marathon Plus € 71.00	<input type="radio"/> XM060 Schwalbe One (24", 25" only) € 99.00		
<input type="radio"/> XM040 Shox solid airless € 117.00 <i>(Black) (24", 25" only)</i>	<input type="radio"/> XM050 Kenda K885 mountain bike tyre (24", 25" only) € 28.00		
Inner Tube Valve Options			
<input type="checkbox"/> XY500 Schraeder inner tube valve <i>(Standard if no option selected)</i>	<input type="checkbox"/> XY490 Presta inner tube valve		
Wheel Accessories			
<input type="radio"/> XK220 Titanium 130mm quick release axle pins <i>(pair)</i> € 119.00 <i>(N/A with XK010 & XK070)</i>	<input type="radio"/> XK300 Offroad wheel set 22" rim with handrim, MTB tyre and axle pins <i>(Replaces 24" wheel with XM010)</i> € 674.00		
<input type="radio"/> XK240 Quad release axle nuts <i>(pair)</i> € 162.00	<input type="radio"/> XK310 Offroad wheel set 24" rim with handrim, MTB tyre and axle pins <i>(Replaces 25" wheel with XM010)</i> € 674.00		

FRAME FINISH OPTIONS

Frame

Components (Footrest, camber bar, sideguards)

 XN010 Powder coated frame

 XN150 Powder coated components

Frame	Comp.	<u>Gloss</u>
<input type="checkbox"/>	<input type="checkbox"/>	Black gloss 103
<input type="checkbox"/>	<input type="checkbox"/>	White gloss 100
<input type="checkbox"/>	<input type="checkbox"/>	Grey gloss 132
<input type="checkbox"/>	<input type="checkbox"/>	Cream gloss 135
<input type="checkbox"/>	<input type="checkbox"/>	Red gloss 108
<input type="checkbox"/>	<input type="checkbox"/>	Yellow gloss 120
<input type="checkbox"/>	<input type="checkbox"/>	Forest green gloss 143
<input type="checkbox"/>	<input type="checkbox"/>	Green gloss 107
<input type="checkbox"/>	<input type="checkbox"/>	Dark blue gloss 151
<input type="checkbox"/>	<input type="checkbox"/>	Royal blue gloss 154
<input type="checkbox"/>	<input type="checkbox"/>	Blue gloss 174
<input type="checkbox"/>	<input type="checkbox"/>	Duckegg blue gloss 141
<input type="checkbox"/>	<input type="checkbox"/>	Pink gloss 188
<input type="checkbox"/>	<input type="checkbox"/>	Orange gloss 180
<input type="checkbox"/>	<input type="checkbox"/>	Purple gloss 157

Frame	Comp.	<u>Matt</u>
<input type="checkbox"/>	<input type="checkbox"/>	Black matt 105
<input type="checkbox"/>	<input type="checkbox"/>	White matt 101
<input type="checkbox"/>	<input type="checkbox"/>	Grey matt 131
<input type="checkbox"/>	<input type="checkbox"/>	Light grey matt 133
<input type="checkbox"/>	<input type="checkbox"/>	Navy blue matt 152

Frame	Comp.	<u>Special</u>
<input type="checkbox"/>	<input type="checkbox"/>	Chrome Mirror 300
<input type="checkbox"/>	<input type="checkbox"/>	Sparkle silver 170
<input type="checkbox"/>	<input type="checkbox"/>	Metallic black matt 104
<input type="checkbox"/>	<input type="checkbox"/>	Metallic grey matt 130
<input type="checkbox"/>	<input type="checkbox"/>	Black sandpaper 201
<input type="checkbox"/>	<input type="checkbox"/>	Grey sandpaper 202
<input type="checkbox"/>	<input type="checkbox"/>	White sandpaper 200

Custom

 XN200 Custom paint colour
€ 179.00

Frame	Comp.	Select colour/RAL:
<input type="checkbox"/>	<input type="checkbox"/>	

UPHOLSTERY

Seat Uphostery

 XP040 Seat sling adjustable tension with straps

 XR050 Carbon fibre seat plate
€ 353.00

Backrest Upholstery

 XP030 Nylon backrest strap adjustable

 CMSXP190 Airtech backrest strap adjustable
€ 145.00

 XP060 Backrest upgrade to full leather
€ 362.00 (select colour)

 XP070 Backrest upgrade to leather corners
€ 125.00 (not with flip down push handles (select colour))

 Black (Std)

 Red

 Black (Std)

 Red

Backrest Uphostery Stitching Options (Only with CMSXP190)

 Silver
(Standard if not indicated)

 Black

 Blue

 Red

 Light blue

 Purple

Backrest Uphostery Logo Options (Only with CMSXP190)

 Silver
(Standard if not indicated)

 Black

 Blue

 Red

 Light blue

 Purple

Backrest Accessories

 XP110 Backrest with zip pocket
€ 93.00

 XP170 Individual backrest embroidery
€ 143.00 (Please provide .jpeg file and positioni)

CUSHION

- XP080 Cushion foam with nylon cover
 € 87.00 *(select density and size below)*
- | | | |
|--|--|---|
| <input type="checkbox"/> Soft (CMS040) | <input type="checkbox"/> Medium (CMS050) | <input type="checkbox"/> Hard (9lb recon) |
| <input type="checkbox"/> 50mm | <input type="checkbox"/> 75mm | <input type="checkbox"/> 100mm |

Cushion cover options

- XP090 Air Lite cushion cover
 € 67.00 *(Black)*
- XP100 Leather cushion cover
 € 222.00 *(select colour below)*

- Black (std) Red Grey

Jay Cushion

- XP250 JAY Extreme Active fluid pad
 € 680.00 *(Price subject to change dependant on size)*
- XP251 JAY Easy Visco
 € 252.00 *(Price subject to change dependant on size)*

Other Jay cushion, please specify code, cost, size and description:

FRAME OPTIONS

- XR060 Welded calf strap mounting loops
 € 106.00 *(To locate calf strap on front frame)*

Specify height from floor

- Optimise measurements

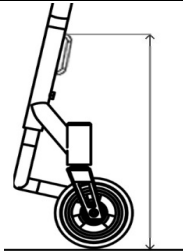

ACCESSORIES

- XR080 Frontwheel assembly
 € 761.00 *(Only with XB010, TGAXB080, XB150)*

(Office use only)

Frontwheel serial number:

- XP420 Frame protectors nylon with velcro fasten
 € 50.00
- XR190 Phoenix Unstoppable gear bag
 € 557.00
- XR200 Rucksack with RGK logo (Black)
 € 66.00
- XR010 Seat pouch velcro attach (Black)
 € 40.00
- XR020 Underseat large storage bag (Black)
 € 93.00
- XR090 Tool kit
- XS060 Calf strap

NOTES

Blank rectangular area for notes.

Grid area for notes.

Data Privacy - Customer Order Forms

This data privacy notice tells you about the personal data we collect from you when you purchase one or more of our products. In collecting this personal data, we are acting as a data controller and, by law, we are required to provide you with information about us, about why and how we use your data, and about the rights you have over your data.

Who are we?

We are RGK Wheelchairs. Our address is Units 8a/b/c Ring Road, Zone 2, Burntwood Business Park, Burntwood, Staffordshire, WS7 3JQ UK

You can contact us by post at the above address, by email at data.enquiries@rgklife.com or by telephone on +44 (0)1543 670077 - Any enquiries about our use of your personal data should use the contact details above.

What personal data do we collect?

When you purchase products from us, we ask you for your name, address, contact telephone number, email address. Where necessary some personal details such as; height, weight, limb measurements and any disability or disease will be required. To fulfil your order (unless under contract) we will also need your bank account details.

Why do we collect this personal data?

We will use your personal data to allow the configuration and/or customisation of your purchase, process your order and to send you your goods. We will also send you an invoice and a delivery note. If we have a question about your delivery we will use your telephone number or email address to contact you.

We process special personal data (Health) for the purposes of the provision of healthcare treatment and manufacturing of your product. The Lawful basis for processing normal personal data is Legitimate Interest this enables us to complete your order, process your payment, deliver your goods and fulfil our contract with you.

What do we do with your information?

Your information is stored in our order processing system which is based within the European Union.

We use a third-party courier companies to deliver your goods and we share with them your name, address and telephone number in order to complete the delivery.

We do not use the personal data you provide to make any automated decisions that might affect you. Your data will be shared with an external dealer (if required) and internally with our Sales Team, Customer Services, Financial Services and Quality/Warranty departments to enable fulfilment of your order and provide support services.

How long do we keep your personal data for?

Your non-financial data will be stored for the period of the warranty of the particular product purchased for a maximum of five years.

Your financial data will be stored for seven years as is required by UK Law.

Your rights over your personal data

By law, you can ask us what personal data we hold about you. You can request a copy, correct it if it is inaccurate, request we erase it, and transfer a copy to another data controller.

You can also ask us to stop using your data if you believe we are not processing it lawfully.

To submit a request by email, post or telephone, please use the contact information provided in the 'Who are we?' section.

Your right to complain

If you have a complaint about our use of your information, you can contact the Information Commissioner's Office via their website at www.ico.org/concerns or write to them at:

Information Commissioner's Office
Wycliffe House
Water Lane
Wilmslow
Cheshire
SK9 5AF