



DALMATIAN INVENTO™

MULTIFUNCTIONAL STANDER



USER MANUAL

Our passion - your independence!

AKCESMED[®]



CAUTION! Manufacturer takes responsibility for proper usage of the device only when the product was purchased from qualified Akces-Med employee or at specialized medical store!

CAUTION! AKCES-MED Ltd. reserve the right to introduce technical and trading changes in the content of the instruction without warning.

Medical product first class according to the Regulation 93/42/EWG of European Parliament and Council regarding medical products. For this product the producer issued relevant declaration of conformity.

Akces-Med. Sp. z o.o. Company introduced quality management system ISO 13485 regarding production, sales and service. The system is certified by Det Norske Veritas.





CONTENTS

1. The purpose of user manual.....	5
2. Indications for use.....	5
3. General characteristics.....	6
3.1 Standard equipment.....	7
3.2 Additional equipment.....	9
4. Size table.....	8
5. Detailed description on how to use multifunctional stander	10
I. POSITIONING CHAIR.....	10
II. LYING FUNCTION.....	17
III. STANDING FRAME.....	18
6. Additional equipment.....	19
6.1 Footers with adjustment.....	19
6.2 Cushions for upper limbs support	19
6.3 Independent adjustable side pelottes.....	20
6.4 Adjustment of thigh abduction belts.....	20
6.5 Head stabilizing belt.....	21
6.6 Soft cover for tray.....	21
6.7 H harness.....	22
6.8 6 point harness.....	22
6.9 Tray for manual therapy	22
7. The use of multifunctional stander	23
7.1. Preparation of the patient.....	22
7.2. How to use multifunctional stander	23
7.3. Sitting position	24
7.4. Upright position	26
8. Safety rules.....	27
9. Maintenance and cleaning	30
10. Labelling.....	32





INTRODUCTION

DALMATIAN INVENTO™ is widely used in the process of rehabilitation. It is recommended for not only children but also young people. It is used as a rehabilitation chair during adopting the sitting position and then as a static standing frame in the further process of rehabilitation. Besides, it can be a lying function during the whole process. This device is equipped with the gas spring thanks to which both therapists and care takers can put the child in upright position without removing him from the chair. This multifunctional device completes the process of rehabilitation due to adjustment and equipment. Upright standing may be performed from 0 to 90 degrees. Moreover, safety vest and pelvic belt are equipped with innovative “hold & pull” system which allows for quick and precise stabilization of the child in the device. As far as this product is concerned, it is created from ecologic materials and it is hand painted.

Remember to read this user manual carefully. You will find not only useful information but also guidelines regarding safe and effective use of the product.

If you have any questions or remarks, do not hesitate to contact our medical consultant (ph. 508 382 509) or directly AKCES-MED Sp. Z o.o. (ph. 17 864 04 70).

Thank you for purchasing our product.



CAUTION! Before using the product, user is obliged to familiarize himself/herself with user manual. Remember that complying with guidelines is highly important. It assures safety and extends durability as well as aesthetics of the device.





1 THE PURPOSE OF USER

The present user manual contains basic information which is essential for proper usage, preparation, maintenance, cleaning and guarantee conditions regarding **DALMATIAN INVENTO™** multifunctional stander.

User manual should be kept in easily accessible place. It is designed for people who look after disabled children, and for both doctors as well as physiotherapists who operate the device.



CAUTION! Before using the product, user is obliged to familiarize himself/herself with user manual.

Remember that complying with guidelines is highly important. It assures safety and extends durability as well as aesthetics of the device.

2 INDICATIONS FOR USE

The device is recommended for people in the following cases:

- Infantile cerebral palsy – different types.
- Brain and spinal cord damage of different etiology with limb paresis, severe balance and coordination disorder.
- Menigomyelocele defect.
- Demyelinating diseases (multiple sclerosis, amyotrophic lateral sclerosis and others).
- Muscle diseases connected with paresis and paralysis.
- Genetic disorders connected with paresis.
- Rheumatic diseases.



3 GENERAL CHARACTERISTICS OF STANDER

3.1. Standard equipment

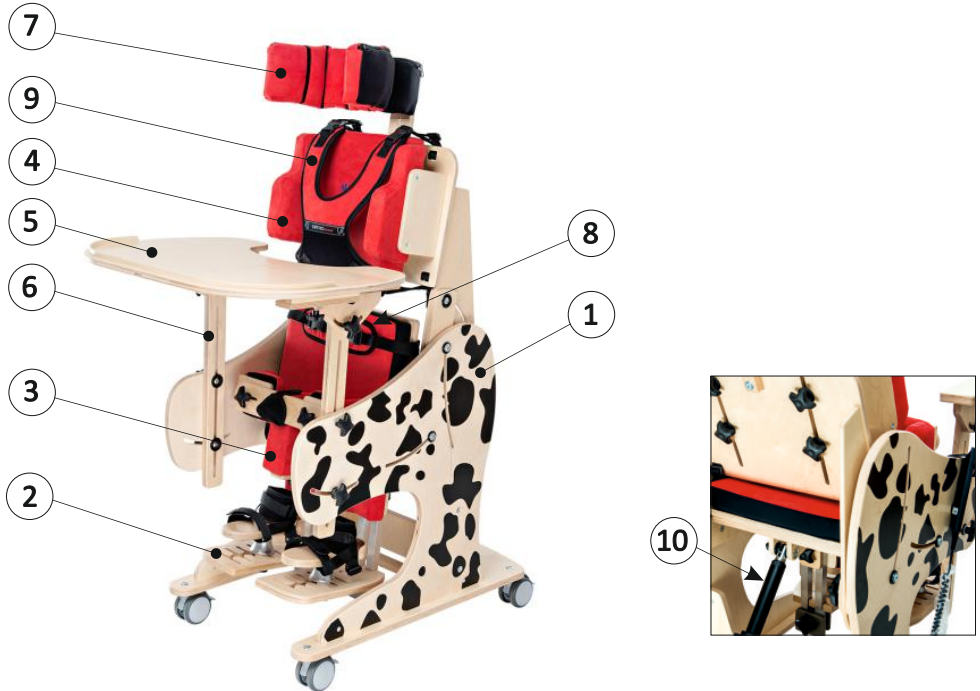

- 1. Frame with castors
- 2. Footrest with feet stabilizing belts
- 3. Abduction block with knee support
- 4. Chest pelottes
- 5. Tray
- 6. Upper limb support
- 7. Adjustable headrest
- 8. Pelvic belt
- 9. Vest
- 10. Gas spring





3.2. Additional equipment



DM_126 Trunk belt



DM_410 Headrest cotton cover



DM_102 Head supporting belt



DM_003 Soft cover for tray



DM_407 Tray for nonverbal communication



DM_401 Tray for manual therapy



DM_109 Independently adjustable side supports



DM_103 3D foot adjustment



DM_106 Lower limbs supporting cushions



DM_507 Oxygen tank holder

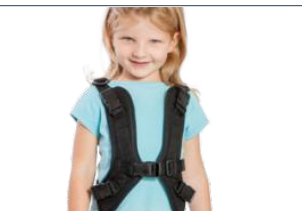

DM_114 H harness



DM_125 6 points safety vest



DM_002 AID for MOVING PATIENTS AM-P



DM_123 Longer headrest



DM_101 Thigh abduction belts





DM_080 Elastico cushion backrest



DM_412 Elastico cushion seat



DM_421 Seat cushion (thighs shape)



DM_427 Tango wheel





4 SIZE TABLE

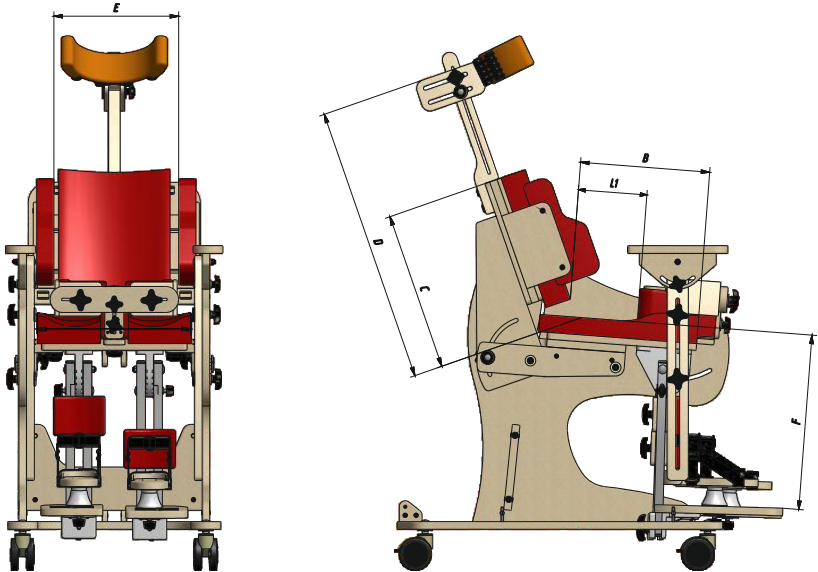

Symbol	Measurement	Unit	Size 1	Size 2	Size 3
A	seat width	[cm]	33	36	45
B	seat depth	[cm]	17-26	20-31	28-44
C	backrest height	[cm]	28	35	47
D	headrest height	[cm]	40-60	47-71	54-77
E	backrest width	[cm]	16-22	18-26	18-32
F	footrest length	[cm]	18-40	18-40	18-51
	knee supports spacing	[cm]	18-26	21-29	25-37
	footplate length	[cm]	19	22	25
	standing frame tilt angle	[°]	0-85	0-85	0-85
	tray tilt angle	[°]	67-80	74-97	95-112,5
	backrest tilt angle	[°]	0-90	0-90	0-90
	footrests tilt angle	[°]	0-90	0-90	0-90
	maximum user weight	[kg]	25	45	60
Weight and dimensions of the device			Size 1	Size 2	Size 3
	width	[cm]	46	50	60
	length - sitting position	[cm]	70	81	97
	height - sitting position	[cm]	96	118	138
	weight	[kg]	29	33,5	53

Note: Dimensional tolerance in the table is: +1/-1 cm.





5 DESCRIPTION HOW TO USE MULTIFUNCTIONAL STANDER

I. POSITIONING CHAIR

5.1 The adjustment of seat

Please follow these steps so as to adjust the depth of seat:

- loosen 4 fastening knobs situated under the seat,
- adjust the depth of seat at your discretion,
- tighten knobs.



Please follow these steps so as to adjust the tilt angle of seat:

- press pedal situated at the back of chair and at the same time adjust the tilt angle of seat at your discretion,
- block seat, release pedal.



It is always better to adjust it when patient is placed in the device because his/her weight makes it easier to cope with spring force, otherwise you need to use more strength.





5.2 The adjustment of backrest's tilt angle

Please follow these steps so as to adjust the tilt angle of backrest:

- loosen fastening knobs,
- adjust the tilt angle of backrest at your discretion,
- tighten firmly fastening knobs.



5.3 The adjustment of trunk pelottes

Please follow these steps so as to adjust trunk pelottes:

- loosen 4 fastening knobs,
- adjust the width and the height of pelottes in compliance with patient's measurements,
- tighten knobs.





5.4 The adjustment of feet support

a) Please follow these steps so as to adjust the height of footers:

- loosen fastening knobs,
- adjust the height of footer at your discretion,
- tighten knobs.

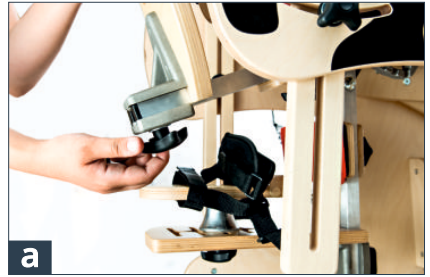

b) Please follow these steps so as to adjust the tilt angle of footrest:

- loosen fastening knobs situated at the side of each footrest
- adjust the tilt angle at your discretion
- tighten knobs



5.4.1. How to adjust new generation footrest tilt angle

- Pull the lock pin on the footrest and adjust needed tilt angle
- Release the lock pin when the needed footrest position have been set up





5.5 Abduction block with knee support

a) Please follow these steps so as to adjust abduction block:

- loosen fastening knob,
- move abduction block either forwards or backwards,
- tighten knob.



a) Please follow these steps so as to mount knee support

- unscrew significantly fastening knob situated at the front of abduction block,
- insert knee support,
- tighten fastening knob.



b) Please follow these steps so as to adjust knee stabilizing pelottes

- loosen knobs fastenings knee pelottes,
- adjust the distance of pelottes at your discretion,
- tighten fastening knobs.





CAUTION! If vest and pelvic belt are mounted, it is necessary to make sure that

- buckles do not unfasten under pressure
- buckles do not shift due to incorrect assembly

5.6 The adjustment of headrest

a) Please follow these steps so as to adjust headrest:

- loosen fastening knobs situated at both sides of headrest,
- adjust headrest,
- tighten firmly fastening knobs.

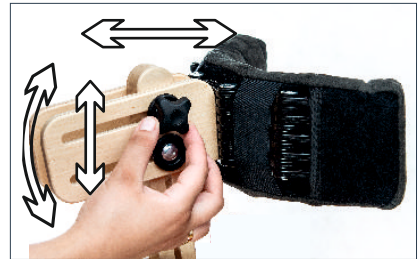

b) Next, it is important to:

- loosen screws from headrest's ribbing with the aid of Allen key,
- adjust the shape of headrest at your discretion,
- tighten firmly screws.



HexagonPro© Headrest

The headrest may be adjusted with Allen key. You can also change the width of the headrest. After adjustment, there is necessary to screw all of screws and bolts tightly!



fig.20



fig.21



fig.22





CAUTION! Shin cannot be squeezed by seat or any other elements of seat.

5.7 Assembly and adjustment of vest

Please follow these steps so as to mount vest:

- fasten 4 fastening buckles,
- pull cotters so as to adjust the vest at your discretion.



5.8 Assembly and adjustment of pelvic belt

Please follow these steps so as to mount pelvic belt:

- fasten two fastening buckles,
- pull cotters so as to adjust the length of belt at your discretion



5.9 Assembly and adjustment of tray

Please follow these steps so as to mount tray:

- loosen fastening knobs situated under tray's top,
- adjust upper limb support at the same height,
- place tray on upper limb support,
- tighten fastening knobs.





5.10 The adjustment of upper limb support

Please follow these steps so as to adjust the height of upper limb support:

- loosen two fastening knobs that bolt batten with upper limb support,
- adjust the height and tilt angle of upper limb support at your discretion,
- tighten fastening knobs.



Please follow these steps so as to adjust the tilt angle of upper part of upper limb support

- loosen fastening knob,
- adjust the tilt angle at your discretion,
- tighten fastening knobs.





II. LYING FUNCTION

If you wish to adjust chair to lying position it is necessary to adjust two footrest and backrest horizontally. Points 5.2 and 5.4b clearly show how footrest and backrest should be adjusted.



Knee support in lying position

a) Knee support in lying position is mounted on upper part of abduction block;

b) Adjust the height of knee support with the aid of knob situated at the front of abduction block;

c) It is possible to adjust standing frame. Please follow steps described in point 5.5
(Look point 5.5, Knee support, page 13).





III STANDING FRAME

Please prepare the device for lying function if you want to move on to upright standing. This process is described on page 17 (**Look point II LYING FUNCTION, page 17**).

Mount knee support and move on to upright standing once all elements are prepared and adjusted to the patient. Unblock safety mandrel, press pedal (a) and place the patient in a proper position (b).



CAUTION! It is important to make sure that both vest and pelvic belt are correctly fastened and adjusted before upright standing. Furthermore, check if knee support is properly mounted and , moreover, make sure that knee support protects legs from bending.

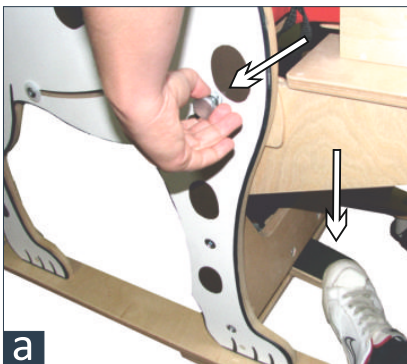



CAUTION! Please always make sure that patient's body parts are not placed between movable elements from the device, otherwise patient will hurt.

6 ADDITIONAL EQUIPMENT

6.1 Footers with adjustment

Please follow these steps so as to mount footers with adjustment:

- dismantle standard footers,
- mount footers with adjustment; mount them in a places where standard footers were mounted,
- adjust footers at your discretion,
- tighten fastening knobs.

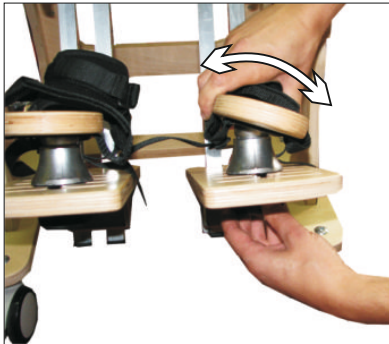

6.2 Cushions for upper limbs support

Please follow these steps so as to mount cushions for upper limbs support:

- unscrew fastening knobs from each cushion,
- put cushions on footrest's profiles,
- adjust the height at your discretion,
- tighten fastening knobs.



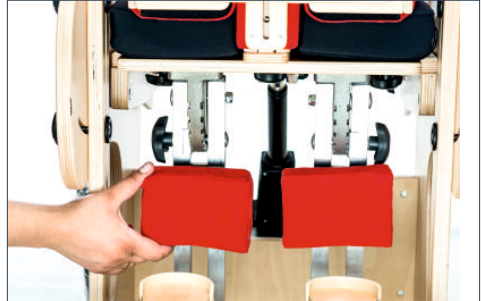
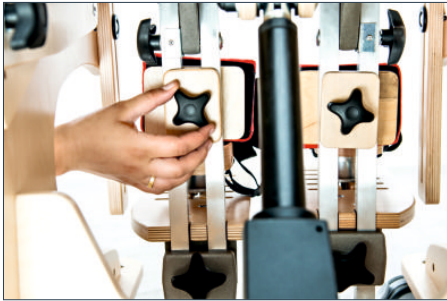

6.3 Independent adjustable side pelottes

Independent adjustable side pelottes are mounted by manufacturer. Please follow these steps so as to adjust them:

- measure patient,
- loosen fastening knobs,
- adjust the distance,
- move pelottes either upwards or backwards so as to adjust them to the patient,
- tighten knobs if height is adjusted.



6.4 Adjustment of thigh abduction belts

Thigh abduction belts are mounted by manufacturer. Please follow these steps so as to adjust them:

- adjust their length at your discretion,
- fasten buckles.



CAUTION! If vest and pelvic belt are mounted, it is necessary to make sure that

- buckles do not unfasten under pressure
- buckles do not shift due to incorrect assembly



6.5 Head stabilizing belt

Please follow these steps so as to mount head stabilizing belt:

- fasten belt to lateral parts of headrest with the aid of Velcro tape,
- adjust the length of belts to patient,
- pull belts so as to check if they are correctly mounted.



6.6 Soft cover for tray

Please follow these steps so as to mount soft cover for tray:

- Adhere 5 adhesive Velcro tapes;
- Put soft cover in a way that its edges cover tray edges.





6.7 H harness

Please look at point 6.6 so as to find out how to assembly vest. **(point 5.6, page 13)**. Initially, patient should not adjust vest tightly. Once vest is put on, it should be fastened with the aid of belts with plastic straps. Vest can be quickly unfastened.

6.8 Tray for manual therapy

Tray for manual therapy is mounted instead of standard tray **(look point 5.9, page 15)**.

6.9 6 points harness

In order to mount 6 points vest it is necessary to:

- points vest should be put on and then it is important to fasten zipper and buckle at the front of vest;



- Adjust vest with the aid of Velcro tapes situated at the back of vest.
- 6 points vest should be fastened in a place that is created for standard vest (point 5.6, page 14). So as to fasten it, use not only buckles but also fastening belt that should be threaded behind chair's backrest and fastened at the front of vest.





7 THE USE OF MULTIFUNCTIONAL STANDER



CAUTION! DALMATIAN INVENTO™ multifunctional stander has to be used with compliance to guidelines included in this user manual. Remember to use the product only with someone who is trained and knowledgeable. Do not forget to prepare both product as well as patient before using **DALMATIAN INVENTO™** multifunctional stander!

7.1. Preparation of the patient

Before using the product, it is essential to make sure that:

- patient's outfit is light and comfortable sporty clothes are advisable,
- shoes should be comfortable and, moreover, they should stabilize ankle,
- due to hygienic reason and to avoid abrasion it is advisable for the patient to always wear clothes when using the device, skin must not be naked especially in places of regular contact with upholstery,
- drains, bags, catheters etc. if applied, have to be secured to function properly and not to disturb during using the product,
- if it is necessary for a patient to wear orthopedic supply (collar, corset, orthosis, shoes) if it is recommended by doctor.



CAUTION! Outfit should protect patient's skin from direct contact with upholstery as well as other parts of equipment.

CAUTION! Only doctor can make a decision concerning using any kind of orthopedic supply!





7.2. How to use multifunctional stander

1. Before use it is necessary to:

- Unfold the device;
- Place the device on even ground;
- Make sure that all parts are serviceable, correctly mounted and stable;
- Block brakes;
- Adjust the device to patient's measurements;
- Undo vest, trunk belts etc so as to place easily the patient in the device
- Place patient in the device;
- Fasten all elements which stabilize patient e.g. vest, trunk belts, feet stabilizing belts etc.;
- Mount additional equipment e.g. tray.

2. In case of patients who have problem with bladder, it is necessary to put special cloth on seat. This cloth can be purchased in pharmacy or medical shops.



CAUTION! Before the product is used, it is highly necessary to make sure that all belts as well as safety equipment are correctly fastened as well as adjusted. What is more, check if they do not become undone due to the pressure and, moreover, make sure that clampings from adjustable elements are firmly tightened!

Equipment works correctly only when the device is adjusted according to patient's height as well as weight. Remember to take all these measurements into account while purchasing the product. Correct adjustment is the most important due to the fact that only then the product is safe. It is forbidden to force child to keep specific position because he/she will feel uncomfortable and it may lead to wrong posture.





7.3. Upright position

CAUTION!

The length of time for upright position process is different for each patient. It is recommended to extend this time during the initial period (adaption period for the change of position). Either doctor or physiotherapist can make decision concerning the length of upright position process. Upright position process has to be always performed under the supervision of trained person!

It is recommended to divert patient's attention during upright position process by:

- manipulation games
- educational games
- touch stimulation and others

CAUTION! It is highly important to adjust the device to the patient before using it!



CAUTION! Make sure that all belts as well as fastenings from adjustable elements are correctly adjusted and fastened.

CAUTION! It is forbidden to leave the patient unattended!

CAUTION! Only trained staff can adjust standing frame to the patient!





CAUTION! As far as first upright standing is concerned, it takes place in rehabilitation, neurosurgery or orthopedics wards. Moreover, it has to be performed together with doctor and physiotherapist due to the fact that medical problems may appear during first treatments such as fainting, drop in blood pressure, dizziness etc. Upright standing is continued in home together with trained staff (rehabilitation technician, district nurse, trained family members).



CAUTION! Incorrect adjustment of the device can lead to side effects such as: fainting, body deformities, overloading joints. It is highly advisable to adjust the device before every use of a standing frame. This adjustment has to be done only by a trained person or therapist. If any of these side effects appear, it is highly important to stop the upright position process, take out the patient from the device and lie him/her down. If these undesirable side-effects still occur it is necessary to contact doctor. If these side effects disappeared, remember to inform doctor so as to make decision concerning further upright position process.





8 SAFETY RULES



CAUTION! DALMATIAN INVENTO™ multifunctional stander has to be used in compliance with guidelines in this user manual.

It is highly important to consult either doctor or physiotherapist in order to make right decision concerning the choice of **DALMATIAN INVENTO™** and its size. It is also essential to familiarize with the guidelines described in user manual before using the device.

1. Before use it is necessary to:

- make sure that there are no damages or different faults which could endanger patient's life; check if all parts are working and are correctly mounted and, moreover, check if they are not broken;
- check if all screws, knobs and all glued, sewed or tapped parts are tightened;
- check if brakes are operating correctly;
- check if buckles are operating correctly;
- sprawdzić prawidłowość działanie sprzączek;
- always use safety belts, Velcro tapes should overlap min. 8cm;
- adjust the device according to patient's measurements and needs e.g. the adjustment of pelottes, footplate etc.;
- make sure that all movable parts and knobs for adjustments are stable and locked;
- secure patient with the aid of elements such as vest, foot stabilizing belts, pelottes, abduction block, headrest. It is highly important to secure patient because it safeguards him/her from falling out. If abduction contracture occurs, it is recommended to use abduction block in order to prevent ulcers between knees;

2. It is forbidden to use the device for different purposes that it is intended to.

3. It is forbidden to use the device when it is damaged or any part is missing.

4. It is forbidden to leave the patient unattended.

5. The device should be used only when there is someone who is trained and knowledgeable.





6. It is forbidden to leave the device and the patient on unstable ground unattended, even if the brake is engaged.
7. It is forbidden to either go up or down the stairs; it doesn't matter if the patient is placed in the device or not.
8. It is important to engage brake during getting into and getting out the device.
9. It's important to make sure that patient doesn't stand on footer during either getting into or getting out the chair.
10. Make sure that all limbs are not close to spokes or other adjustable elements.
11. Although the device and the upholstery are made of fire-resistant materials, please pay your attention when approaching to sources of fire or sources of high temperature during using the device. Moreover, chair shouldn't be stored in rooms with high humidity.
12. Secure chair during transportation in order to avoid any possible damages. Manufacturer doesn't take responsibility for damages which appeared due to improper preparation of the device during transportatio





CAUTION! This device can be only used inside the buildings.

CAUTION! The product contains small parts which children may swallow.



CAUTION! It is forbidden to make any changes concerning stander's structure due to the fact that it is dangerous and it results in losing warranty.

CAUTION! The weight of user should not be bigger than maximal weight described on page 9 where you will find information regarding this issue.

- 1) AKCES-MED Sp. z. o. o sells products free from manufacturing defects or faults.
- 2) Manufacturer gives the purchaser 36-month guarantee from the date of purchase. All defects revealed during warranty period will be repaired free of charge.
- 3) All defects which appear after warranty period can be repaired only when the user will pay for it. This rule doesn't apply to refunded products - user can ask National Health Refund for refund.
- 4) Manufacturer claims that the product can be used for 36 months. User can use this product after this period only when he/she will send the device to manufacturer so as to service it. Next, manufacturer determines again how long the product can be used and, moreover, the date of the next service will be determined.
- 5) If product is damaged, please contact our dealer or AKCES-MED customer service (ph. 17/864 04 70)





9 MAINTENANCE AND CLEANING

DALMATIAN INVENTO™ should be kept clean and used in compliance with the manufacturer's recommendations. The device should be kept in clean, dry and ventilated room. Maintenance as well as cleaning have to be performed at least once a month. Regular cleaning and maintenance of device are indispensable to maintain its correct functionality as well as safety.

It is highly advisable to remember about proper maintenance in order to extend product's aesthetics. So as to do that, it is essential to comply with these guidelines:

1. It is recommended to clean upholstery with the aid of cleaning product, soft sponge and warm water. If you use sponge which is too wet, stain may get bigger, upholstery may be destroyed. It is necessary to remember that the excess of dampness should be removed from fabric before next cleaning. Please rinse upholstery with warm water and clean white cloth once stain is removed.
2. It is forbidden to soak upholstery!
3. It is forbidden to clean upholstery with the aid of hard brushes.
4. It is forbidden to clean upholstery with strong chemical agents such as solvent or caustic chemicals.



CAUTION! Akces-MED. Sp z o. o takes no responsibility for damages caused by use of wrong clearing agent.

5. It is forbidden to soak upholstery during cleaning. Remember that upholstery has to be always dry before using.
6. It is forbidden to clean, make any changes and maintain stroller during using it.
7. All metal as well as plastic elements should be cleaned by hand with the aid of general cleaning products. Remember to familiarize yourself with cleaning product's leaflet.





CAUTION! Remember that upholstery has to be always dry before using!

Before using it is necessary to:

- clean wheels;
- check if base as well as wheels are correctly mounted; check if brake stops turning wheel;
- make sure that all wooden parts e.g. tray don't have splinters;
- check if stroller construction is free of breaks or any kinds of deformities;
- check if all movable parts are working and all screws, nuts, knobs etc. are correctly tightened;
- check if belts, vests, trunk belts, feet stabilizing belts etc are not frayed; check if buckles and clamps work correctly.



CAUTION! Manufacturer takes responsibility only for hidden faults or damages which appeared despite the fact that user complied with the guidelines.

CAUTION! In case of any damages, it is essential to contact the person who sold you the product.





10 LABELLING

10.1. Symbols

	Declaration that the product meets the essential requirements		Protect from sunlight
	Catalog number		Storage temperature limitation
	Serial number		Relative humidity storage
	Please read the manual instructions before use		Dry vertically
	Attention!		Do not chlorinate
	Producer		Do not iron
	Production date		Do not dry in a drum dryer
	The product does not contain		Do not bleach
	Store in a dry place		Careful! delicate content
	Prohibition of use without fastened safety belts		Prohibition to leave the patient without care during use of the product
			Product designed for indoor use

10.2. Example of identification plate

QR code - after scan you are directed to the website of the product

Producers address

Name of product in Polish: DALMATYŃCZYK INVENTO 1 URZĄDZENIE WIELOFUNKCYJNE

Name of product in English: DALMATIAN INVENTO 1 MULTIFUNCTIONAL STANDER

Date of production: 05.2014

Maximum allowable product loading: MAX LOAD: 25 kg

Labeling - look above:

Serial number in the form of a bar code

Serial number: DMI 001/U/1/AA





ORTHOPAEDIC DEVICES MANUFACTURER



Akces-MED Sp. z o.o.

Jasionka 955B

36-002 Jasionka

tel. (17) 864 04 77

www.akces-med.com

e-mail: export@akces-med.com

Authorised Dealer



Date of issue: **25.10.2015**

The last update: **24.04.2017**

Our passion - your independence!